

pewag winner pro chain system G12

Lifting and lashing



Hardened shell –
intelligent core

peTAG solution



Watch out!
More about the intelligent core
on pages 10 and 11.

Content

Strength through versatility and an intelligent profile

Uniqueness, safety and sustainability remain the key features of the pewag winner pro chain system that has been on the market since 2003 and that may be used universally for lifting and lashing operations as well as for customised solutions.

pewag is the first chain manufacturer worldwide to offer an innovative G12 chain system with a unique, intelligent profile and outstanding quality features that sets new standards for the entire industry.



Technical changes and misprints excepted.

pewag group	
Welcome to the pewag group	4-5
History and quality management	6
Business areas and environment	7
Locations	8
peTAG solution	
peTAG solution	10-11
pewag winner pro – Lifting in G12	
Benefits and information	12-16
Sample orders, load capacities in G12, exceptional conditions	17-20
Chains in G12	
Chains in G12	22-25
Master links and sub-assemblies in G12	
Master links and sub-assemblies in G12	26-32
pewag proudly presents – ISWP Shortening element	33
Accessories in G12 – Lifting	
Accessories in G12 – Lifting	34-43
Lashing in G12	
Lashing in G12	44-49
Accessories in G12 – Lashing	
Accessories in G12 – Lashing	50-59
Assembled lashing chains	60-63
Spare parts	
Spare parts	64-69
User information	
User information for pewag lifting program	70-75
User information for pewag lashing program	76-77
Notes	78

Welcome to the pewag group

We are an internationally operating group of companies. Our track record goes back to the year 1479.

Mission Statement

pewag group's Mission Statement expresses the goals of our actions as follows:

With our joy for innovation, we strive to make all products of the pewag group the best in the respective markets. The high quality of our products and services as well as our employees' passionate dedication are the foundation to our pursuit of outstanding services and complete customer satisfaction.

Principles of pewag group

Leading in Quality

The values of our product brands are demonstrated by our first-class quality and innovations and are communicated consistently and coherently.

We anticipate market demands and changes in the environment and adapt our strategies, organizations and actions accordingly to satisfy our customers' needs through providing an optimal price-performance ratio: timely delivery, efficient and obliging service.

Leading in Responsibility

We commit ourselves to careful treatment of the environment, by reducing the use of energy and raw materials, ensuring the longevity of our products and making them recyclable.

We value an open, honest and team-oriented work-style, which is based on transparent communication honoring ideas, opinions and experience of our employees as valuable inputs for our decision making process.

We strive for stable and fair partnerships with our employees, customers, suppliers and other business partners and take social aspects into consideration when making business decisions.

Leading in Technology

We secure our technological strength by striving for product quality, constant improvements and innovations of products, as well as manufacturing processes.

We strive to be the best in product technology. This ensures that our customers always have optimal solutions available and that we expand and protect our market position.

Leading in Economics

In all our processes we use due diligent business practices and efficiency and strive to improve these continuously.

In the long-term, we will continuously increase our economic performance to raise corporate value, achieve sustained growth and thus secure a successful future of the organization.

We are a modern group of companies which looks back to a tradition and experience of more than 500 years. Since our founding years, a lot has changed, but the values that made our success possible from the beginning remain.

**pewag group –
Innovation. Quality. Partnership.**

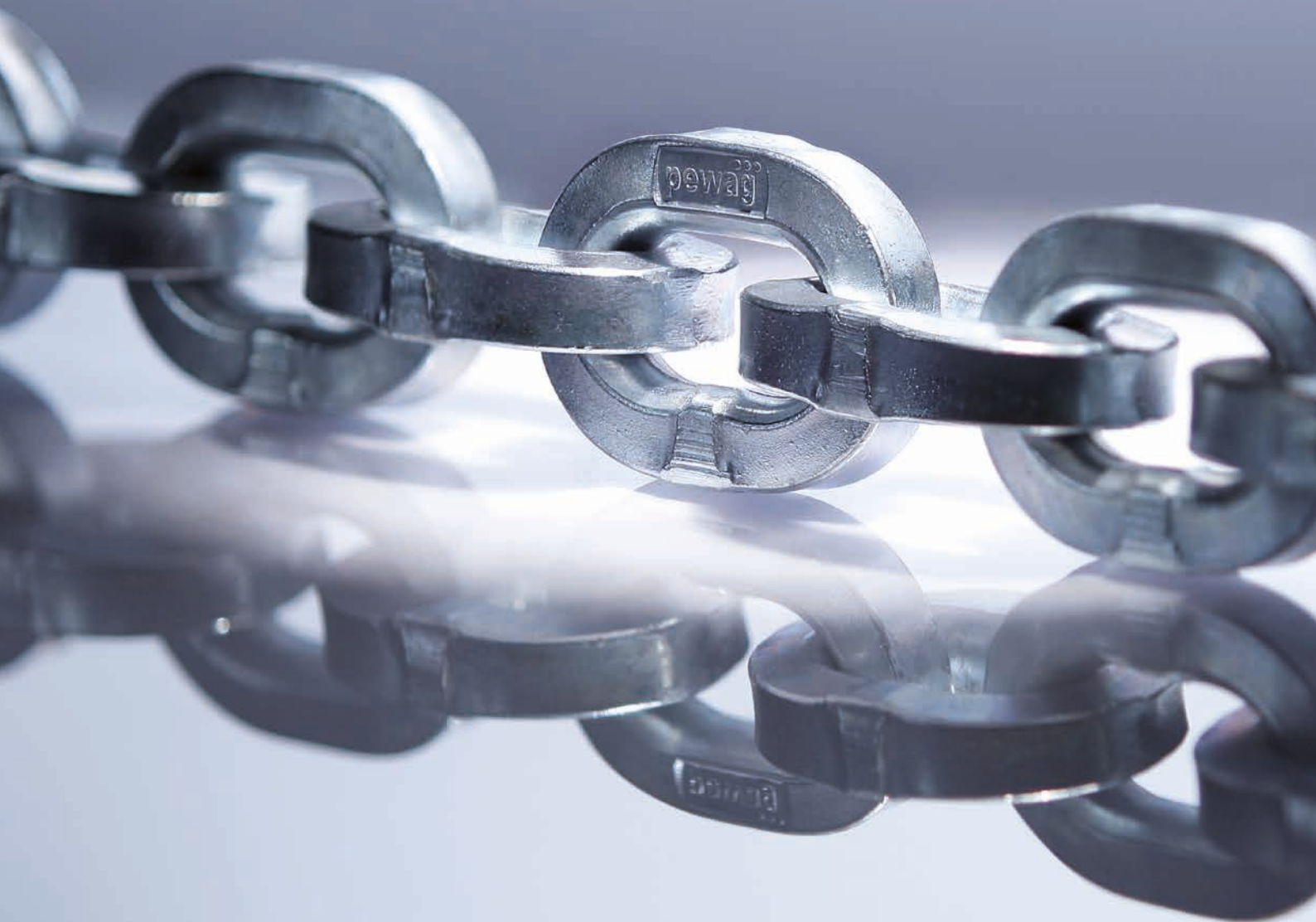

History of the pewag group

Quality management

Advantage through tradition

The history of pewag group goes back to the 15th century and therefore makes us one of the oldest chain manufacturer worldwide. With our experience we are ready for the future.

Timetable of important events

- 1479** First documented references of a forging plant in Brückl
- 1787** Foundation of a chain forge in Kapfenberg
- 1803** Foundation of a chain forge in Graz
- 1836** Establishment of an iron casting plant in Brückl
- 1912** Production of the first pewag snow chain
- 1923** Merger of plants in Graz and Kapfenberg – Creation of the name “pewag”
- 1972** Foundation of a sales company in Germany
- 1975** Foundation of a sales company in the USA
- 1993** Foundation of pewag austria GmbH
- 1994** Foundation of the first subsidiary in Czech Republic
- 1999** Acquisition of the Weissenfels Group
- 2003** Separation from the Weissenfels Group
- 2005** Reorganization into 2 groups:
Schneeketten Beteiligungs AG Group – Snow Chains
pewag austria GmbH Group – Technical Chains
- 2009** Acquisition of Chaineries Limousines S.A.S.
- 2012** Foundation of the first manufacturing company in the USA
- 2013/** Foundation of various international sales
- 2014** companies



Lithography forging plant Brückl 1855



Anchor chain forge 1878



Chain forgers 1956

Our main goal is customer satisfaction.

In this instance, quality means that only those products and services are developed, manufactured and delivered which completely and without compromise satisfy the customer.

The pewag group’s quality policy, is underlined by the following basic principle: **“we supply high-end products and services to our customers that conform to the technical standards and requirements”**, can be summarised in the subsequent four points.

Market-oriented Quality

In order to maintain and to widen the competitive position of the pewag group, the quality of finished goods and services must be consistent with the specifications of the customer and also with their expectations of one of the leading companies. No product should ever pose a danger to people or the environment.

Economic Quality

As a profit-oriented company, quality is achieved by taking into consideration the material, personnel and financial resources; this means that we establish an appropriate best price/performance ratio for the customer within the acknowledged framework.

Quality Responsibility

Stringent demands are placed on all employees to ensure high standards of quality. No matter what hierarchical level, all managers are in charge of managing quality. Every employee within the pewag group should be educated, motivated and instructed by the management team. It is important for promoting high quality awareness that the education and training of employees is at the forefront, as each employee is responsible for the quality of his/her own work.

For each of our employees, the statement **“QUALITY STARTS WITH ME”** must be true!

Process-oriented Quality

The close interaction between sales, product development, production and customer service is regulated within the individual companies by fixed processes and activities, as well as responsibilities with the aim to reach and maintain the defined quality standards.



Business areas

Environment – we take responsibility

Working with pewag products

The pewag group has a substantial and diverse spectrum of products and services.

Our range of products varies from traction chains for tires (snow chains for passenger cars, trucks and special-purpose vehicles, tire protection chains for mining vehicles) over different industrial chains to products for the do-it-yourself sector (light chains, belts, etc.)



Segment A
Snow and forestry chains



Segment B
Hoist and conveyor chains



Segment C
Do-it-yourself



Segment D
Engineering



Segment F
Lifting and lashing chains and accessories



Segment G
Tire protection chains

Ecological awareness in all areas



Our company's manufacturing location in Kapfenberg, Austria, has been used for iron and steel production for over 270 years. A second facility located in Brückl, Austria, was first documented in records dating back to 1479.

Based on this long manufacturing tradition, we take serious responsibility for our products, employees and the environment at all our international locations. Hence, one of our major concerns is to improve energy efficiency and, in doing so, to minimise energy consumption over a long period of time with the development of new production technologies. An important goal is to increase energy efficiency and consequently lower energy demand. Consequently, we develop our products to achieve longer product life-cycles and lower weight but simultaneously, increasing their working load capacities and the safety for our customers. We are committed to upholding all relevant energy and environmental standards by setting clearly defined goals and continually improving our performance. To achieve this goal, we use modern manufacturing technologies. An important step is to provide the necessary resources and to include our employees in the process. We are convinced that well-informed and motivated employees can actively participate in environmental conservation.

Wherever we are unable to avoid an environmental impact, we have set ourselves the goal to continually reduce our energy consumption, waste and environmentally harmful emissions. When purchasing new equipment, we strive to find the best and most efficient technical solution possible. It is important for us to promote the purchase of energy efficient products and services.

Our process-oriented management system regulates the documentation concerning all environmental relevant procedures. It also encompasses preventative measures for possible failures, as well as behavioural instructions for regular and/or extraordinary operational procedures. By systematically monitoring and assessing our environmental activities, we are quickly able to resolve deviances and to take corrective action. This process extends throughout the whole organisation to optimise all business processes. We strive to engage in an open dialogue with our customers, neighbours and authorities to inform them of our energy and environmental engagements.

Through specific communication we want to inform our customers about the environmental aspects of our products – specifically inform them about the longevity of our products. Through meaningful communication, we strive to motivate our suppliers and customers to think – in turn – about their environmental footprint and to put into practice similar environmental standards in their businesses.

Customer proximity

International presence

In the ambitious five-hundred year history pewag has evolved from a small and modest company to a global organization with several subgroups.

With 12 production and 40 sales and other locations on all five continents, pewag documented its claim as one of the world's leading chain manufacturers.

In addition to the numerous locations pewag as an international company relies on his capillary, strong, and professional partner network. These collaborations provide optimal customer service in currently more than 100 countries around the world.

Production and sales locations

Europe

Austria	pewag austria GmbH, Graz pewag austria GmbH, Kapfenberg pewag Schneeketten GmbH, Graz pewag Schneeketten GmbH, Brückl pewag engineering GmbH, Kapfenberg pewag austria Vertriebsgesellschaft mbH, Graz pewag Ketten GmbH, Klagenfurt pewag International GmbH, Klagenfurt
Germany	pewag Deutschland GmbH, Unna pewag Schneeketten Deutschland GmbH, Unna
France	pewag france SAS, Echirolles / Grenoble Chaineries Limousines SAS, Bellac
Italy	pewag italia srl, Andrian
Croatia	pewag d.o.o, Rijeka
The Netherlands	pewag nederland BV, Rijnsburg APEX International BV, Hillegom APEX Automotive BV, Hillegom
Poland	pewag polska Sp z.o.o., Buczkowice
Portugal	pewag Portugal – Comercio de Produtos e Eqibamentos Industriais, Lda, Santo Antão do Tojal
Romania	pewag Romania SRL, Sibiu County
Russia	OOO "PEWAG", Moscow
Sweden	pewag sweden AB, Emmaboda
Slovakia	pewag Slovakia sro, Nováky
Czech Republic	pewag Czech sro, Vamberk pewag Snow Chains sro, Vamberk pewag sro, Vamberk pewag Czech sro, Česká Trebová peform Chrudim sro, Chrudim

Europe

Ukraine	TOV pewag Ukraine GmbH, Lviv
---------	------------------------------

North America

USA	pewag Inc, Bolingbrook, Illinois pewag Inc, Rocklin, California pewag Traction Chain Inc, Pueblo, Colorado
Canada	pewag Canada Inc., Mississauga
Mexico	pewag Mexico SA de CV, Mexico

South America

Brazil	pewag Brasil Comércio de Correntes Ltda., São Paulo
Colombia	pewag Columbia S.A.S, Medellin

Africa

South Africa	pewag chain south africa (pty) ltd., Rivonia
--------------	--

Australia

Australia	pewag australia Pty Limited, Barrack Heights
-----------	--

Asia

India	pewag India Private Limited, Bangalore
-------	--

pewag group presents
itself on the internet. More ...

www.pewag-group.com

www.pewag.com

pewag group –
Innovation. Quality. Partnership.



pewag chains together

The peTAG solution enables cross-company, flexible servicing and administration of a wide range of different objects.

peTAG solution

The intelligent solution for unambiguous object identification, data transfer without media breaks, easy servicing of objects, safe document archiving, efficient interaction with partner businesses and much more.

peTAG info

Smart, free-of-charge access to product-specific information via mobile web.

peTAG manager

Watch your PC and mobile devices work hand in hand with this adaptable, high-performance platform – in any work environment and while increasing data quality at the same time. Expensive add-on reading devices and manual data transfer are things of the past!

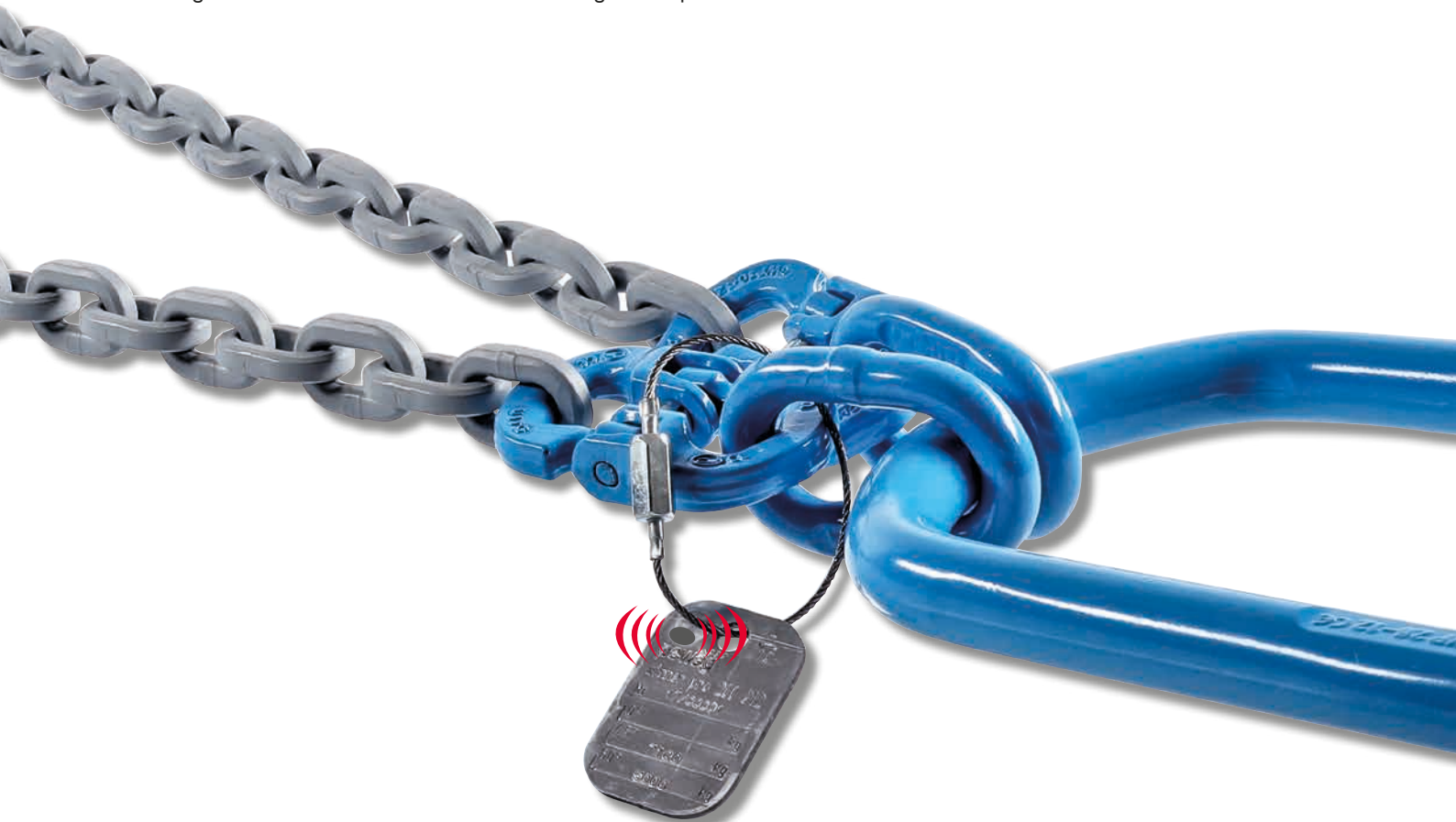

peTAG solution

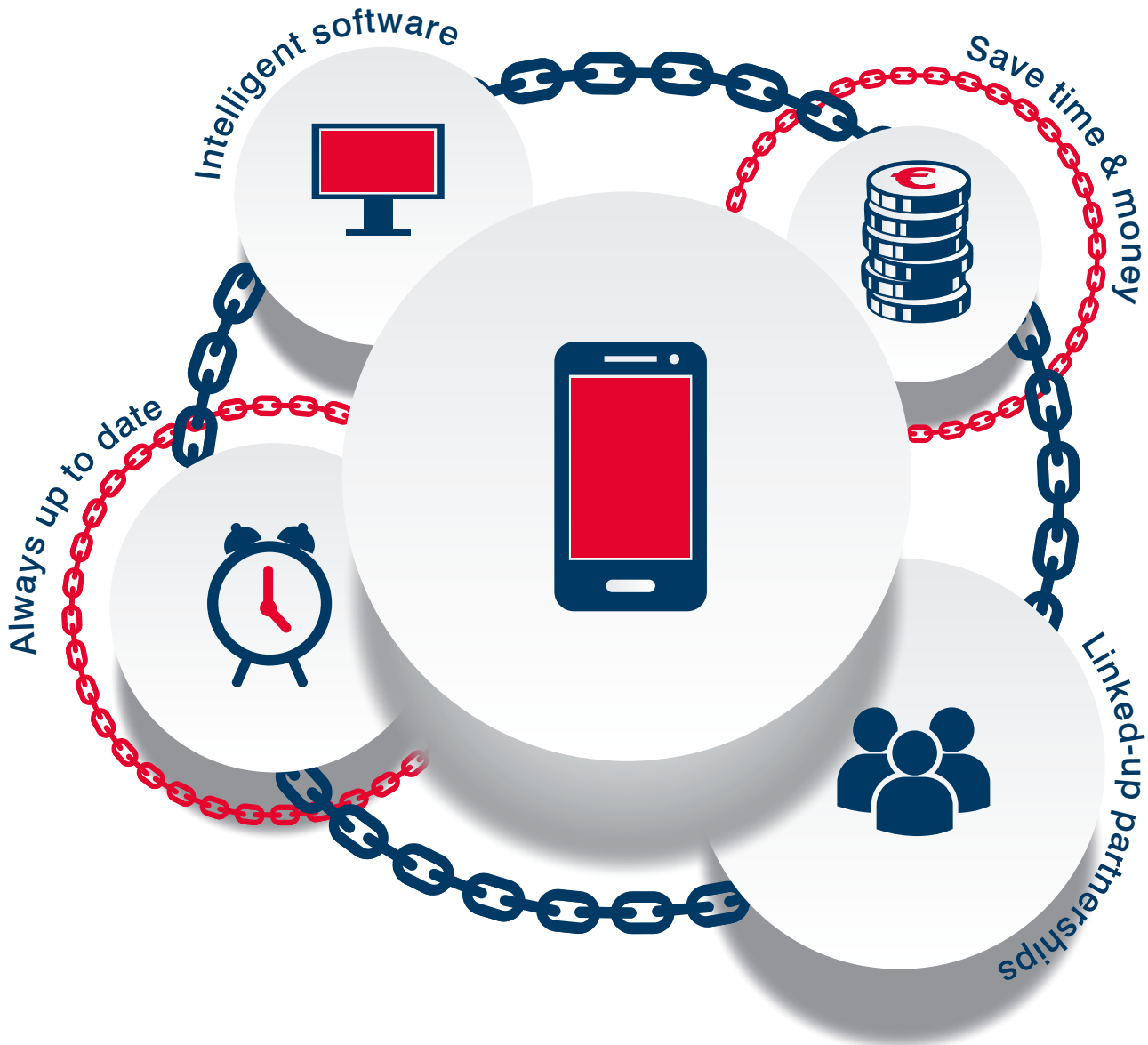

peTAG solution Keyfacts



Intelligent software

User-specific adaptation of object data, testing processes and steps. Automates the creation, sending and archiving of test reports. Sophisticated authorisation concept.



Linked-up partnerships

Straightforward exchange and efficient interaction between service providers, merchants and customers. Improved service and data quality. Increased satisfaction and loyalty.



Save time & money

Efficient documentation of work processes, thus simplified daily workflows. Data exchange without media breaks, fault-free data communication.



Always up to date

Access to the latest product data and information, overview of all test data, documentation of test procedures. Traceability of object history.



Mobile solution

Direct, location-independent data access (e.g. load capacity, safety information, latest test reports etc.) Smart servicing of objects via mobile app. Offline availability.



pewag winner pro

Lifting in G12

Benefits and information

Content

Benefits	14
Key data, history	15
Labelling, New rectangular load capacity tags	16
Order example	17
Load capacities	18-19
Exeptional conditions	20

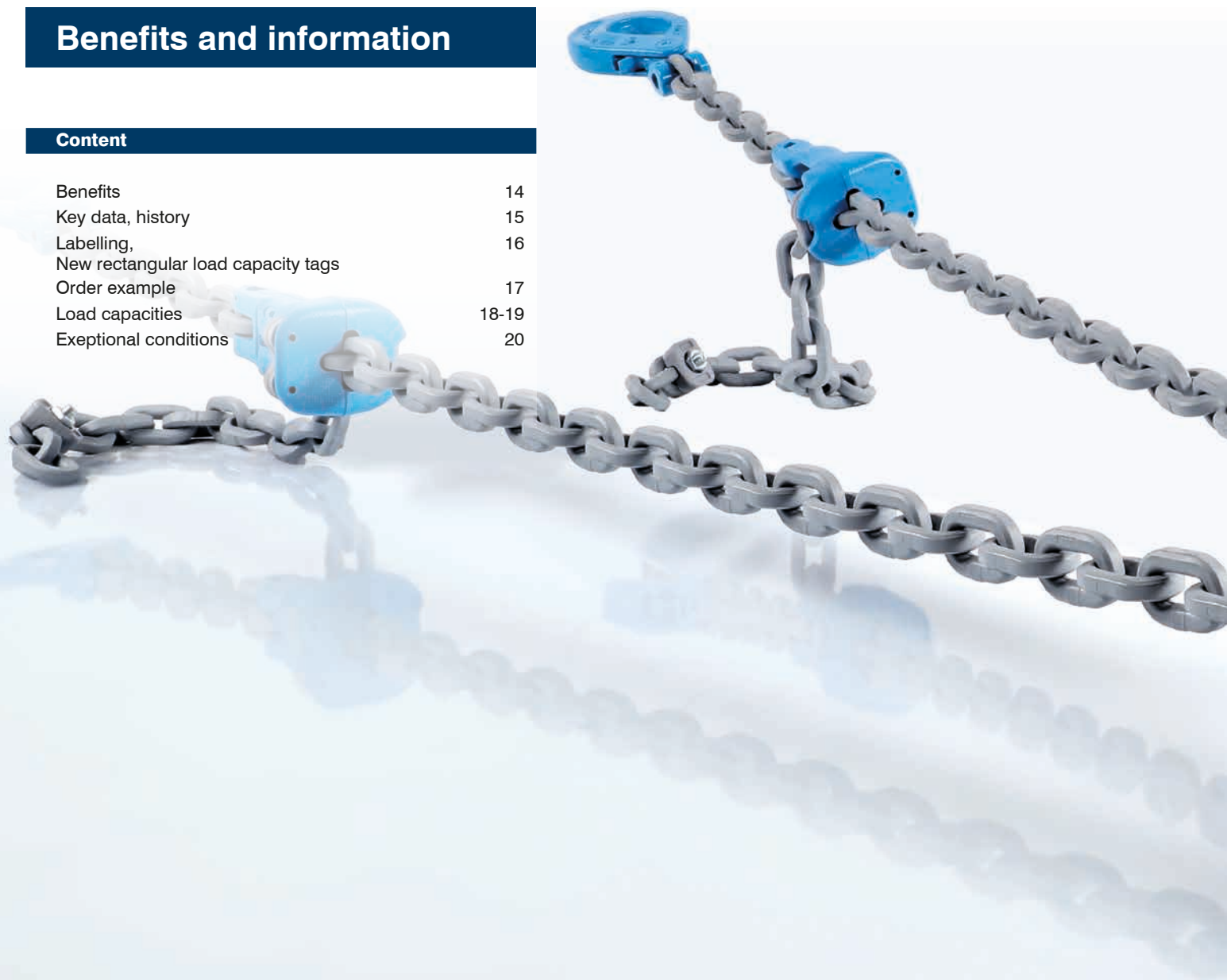





Lifting chains in G12 quality – a chain reaction that was meant to happen

pewag is deservedly proud of its pioneering role when it comes to the production of lifting chains. The pewag name rests on outstanding quality features that are also the core element of our G12 programme: Given the 50 % increase in load capacity compared to the standard G8 programme, the G12 range is significantly lighter, resulting in numerous advantages for routine lifting operations.

Ease-of-use and compliance with all legal stipulations are par for the course and the rock-solid foundation out of which all our products grow. But our G12 products are capable of more: The specially developed chain profile leads to a markedly improved bending resistance, which is particularly helpful when loading the chain over a corner.

- Intelligent profile:** Thanks to the intelligent use of material, the same cross-section achieves a marked improvement of the key characteristics of the chain, for instance fatigue resistance and bending resistance, compared to conventional round-steel chains. The use of material was optimised in key areas (blue sections) and reduced in less relevant areas (red sections) to achieve the best possible technical effects
 

- Optimised bending resistance:** This crucial resistance factor that protects the chain from undesirable bending is up to 6 % higher with the profile chain than with a round-link chain that has the same cross-section. This reduces the maximum tension in the chain (no red sections)
 

Your benefits at a glance:

- 50 % higher load capacity** compared to G8,
20 % higher load capacity compared to G10

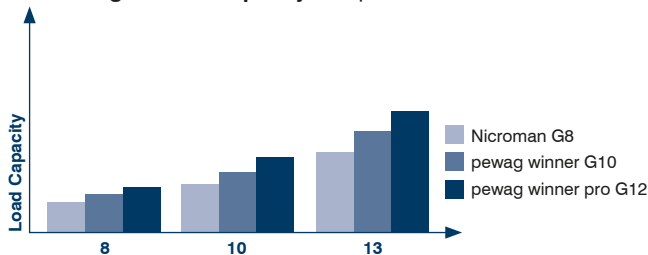

- Significantly reduced weight** and easier handling with pewag winner pro

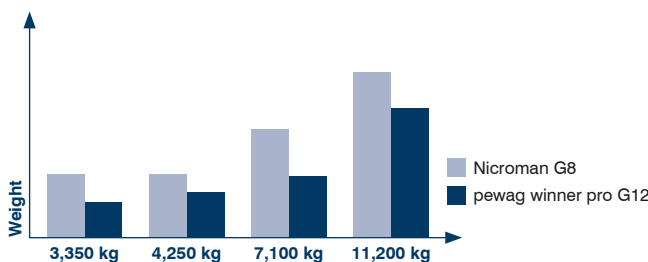

Load capacity	Previous chain weight [kg]	pewag winner pro chain weight [kg]	% Reduction
3,350	16.60	9.37	44 %
4,250	16.60	11.80	29 %
7,100	28.53	19.19	33 %
11,200	43.61	34.10	22 %

Load capacity	chains up to ø	pewag winner pro chains ø
4,250	10 mm	8 mm
7,100	13 mm	10 mm
11,200	16 mm	13 mm

- Highly efficient for many load ranges, as the size of the chain slings is **reduced by one dimension** compared to G8 and G10 chain slings
- Optimised strength and toughness characteristics at high and low temperatures thanks to **patented material**
- pewag winner pro defines the “Formula 1” of technical chains thanks to its **weight-based performance**

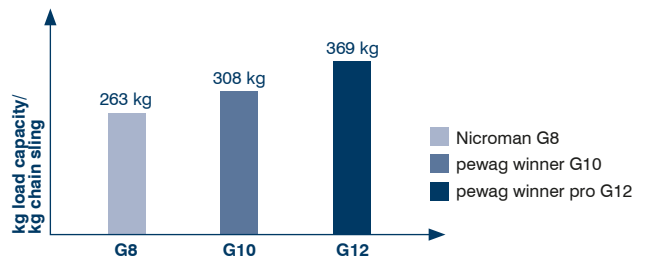

- High stability and a low level of wear guarantee a **longer life span**
- Innovative chain system** that may be used for lifting or lashing; also suitable for many other applications thanks to its robust design
- Complete traceability** thanks to identification stamp on chain and components, enabling users to track the entire manufacturing process
- Easy visual identification** thanks to profile chain and G12 stamp on each chain link
- Light blue powder coating on chains and components for **corrosion protection**, optionally also available with the tried-and-tested corpro coating (PCP) for maximum corrosion resistance (for further information, see specialised brochure). WINPRO 200 chains are painted in light grey
- Maximum safety** thanks to innovative load capacity tag made from rust-resistant material and including safety warnings
- ISO 9001 certification as a testimony to **quality-assured, European manufacturing**
- Simple spare parts ordering system and top-quality service provided by a **global sales network**
- Pioneering role: pewag is the first manufacturer to have launched the innovative G12 chain system, based on its **wealth of experience**

pewag winner pro key data – focus on quality

Top of the range:

- **Chain qualities:**
pewag WINPRO FLEX 200 – based on EN 818-2 with modifications (profile, higher load capacity, reduced operating temperature)
pewag WINPRO FLEX 300 – based on PAS 1061 with modifications (profile, higher load capacity, reduced operating temperature)
- **Stress at load capacity limit:** 300 N/mm²
- **Test stress:** 750 N/mm²
- **Breaking stress:** 1,200 N/mm²
- **Breaking elongation:** min. 20 %
- **Bending according EN 818-2 and PAS 1061:** 0.8 x d
- **Admissible operating temperature:**
pewag WINPRO FLEX 200: -40 °C – 200 °C
pewag WINPRO FLEX 300: -60 °C – 300 °C
- **Quality grade stamping**
pewag WINPRO FLEX 200: „PEWAG12“ / „200“ on every 20th link and 12 on the back of each link
pewag WINPRO FLEX 300: „PEWAG12“ every 300 mm and 12 on the back of each link
Components: 12
- **Manufacturer's name or symbol:** D16 and/or pewag
- **Surface:**
pewag WINPRO FLEX 200: light grey coating
pewag WINPRO FLEX 300: light blue powder-coating – or black coropro (PCP) coating
Components: light blue powder-coating
- **Sling tag:** Shows required data according EN 818-4
- **Compatibility:**
Please note that the compatibility of pewag winner pro chains and components with those of other grades and from other manufacturers is limited! For this reason, any combinations shall be approved by pewag in advance.

All dimensions in this catalog are nominal dimensions
Depending on the manufacturing process they are subject to various manufacturing tolerances.
Please contact our customer service if required.

pewag winner pro – a portfolio makes history

- 1997** pewag first embarks on the development of a profiled, case-hardened hoist chain
- 1998** pewag is the first manufacturer worldwide to have its profile hoist chain approved by the German employer's liability insurance association in accordance with EN 818-7 for chain type DAT with H16
- 2000** Start of series production for hoist profile chains
- 2001** pewag embarks on the development of the next generation of chains and accessories in G12
- 2003** pewag is the first manufacturer worldwide to successfully launch a G12 lifting equipment range in the US
- 2004** Patent specification for high-performance chain steel for manufacturing G12-chains PCT/CH 2004/000568 is granted

pewag receives the prestigious Pinnacle Award for the most innovative product in the lifting industry from renowned US magazine "Lift and Access"

Utility model specification no. AT 006 802 U1 for lifting chains with break stress of 1,200 N/mm² is completed
- 2008** pewag winner pro chain system G12 is approved by German employer's liability insurance association and authorised to use the "D16" mark

The G12 range celebrates its 5-year anniversary at the CeMAT 2008 in Hannover
- 2014** Launch of pewag winner pro clevis sling hook
- 2016** winner pro flex profile has been introduced and the winner pro flex 200 chain was launched
- 2017** Starting the expansion to become the provider of the most comprehensive lifting product range in G12

Novelty: rectangular load capacity tag

pewag sets great store by continuously developing its products further. For this reason, our load capacity tags now come in a square shape that offers numerous advantages and constitutes another step towards maximum safety. The tags are made from rust-resistant material and fastened to the chain sling with a rust-resistant, quick-release mechanism, thereby increasing safety for the user. This will eliminate an error with potentially serious consequences that occurred repeatedly in the past:

In all the standard documents for lifting chains, the number of corners of the identification tag corresponds to the grade category of the lifting chain. This has repeatedly caused users to assume that the load capacity is based on the number of corners and the chain dimension, without checking the actual stamp on the load capacity tag. However, standards only ever describe the minimum requirements of a product and may of course be exceeded.

With its rectangular load capacity tags, pewag eliminates this potential mistake before it can happen and offers users the following advantages:

- Prevention of miscalculated load capacity of the chain sling as checking the load capacity tag prior to each lifting operation becomes unavoidable
- If the marking is not observed, the lifting chain will be classed as a maximum grade 4
- Rust-resistant and therefore also resistant to acids, caustic solutions and their vapours
- Easily exchangeable thanks to rust-resistant rope with quick-release fastening mechanism
- Possibility of customer-specific markings as all information is engraved
- Pre-stamped year dates for periodic inspections make it immediately apparent when the last inspection took place
- For periodic inspections, only the month will be stamped

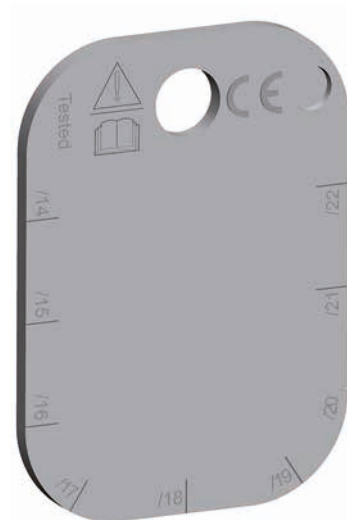

Safety is key for the pewag winner pro load capacity tag.

Sample order text for pewag winner pro lifting products

This is a sample order for a fully adjusted, commercially available pewag chain sling: a pewag winner pro 8 mm, II-leg chain sling with shortening option and safety hook, assembled with Connex connecting links (length: 3,500 mm).

Connex system:

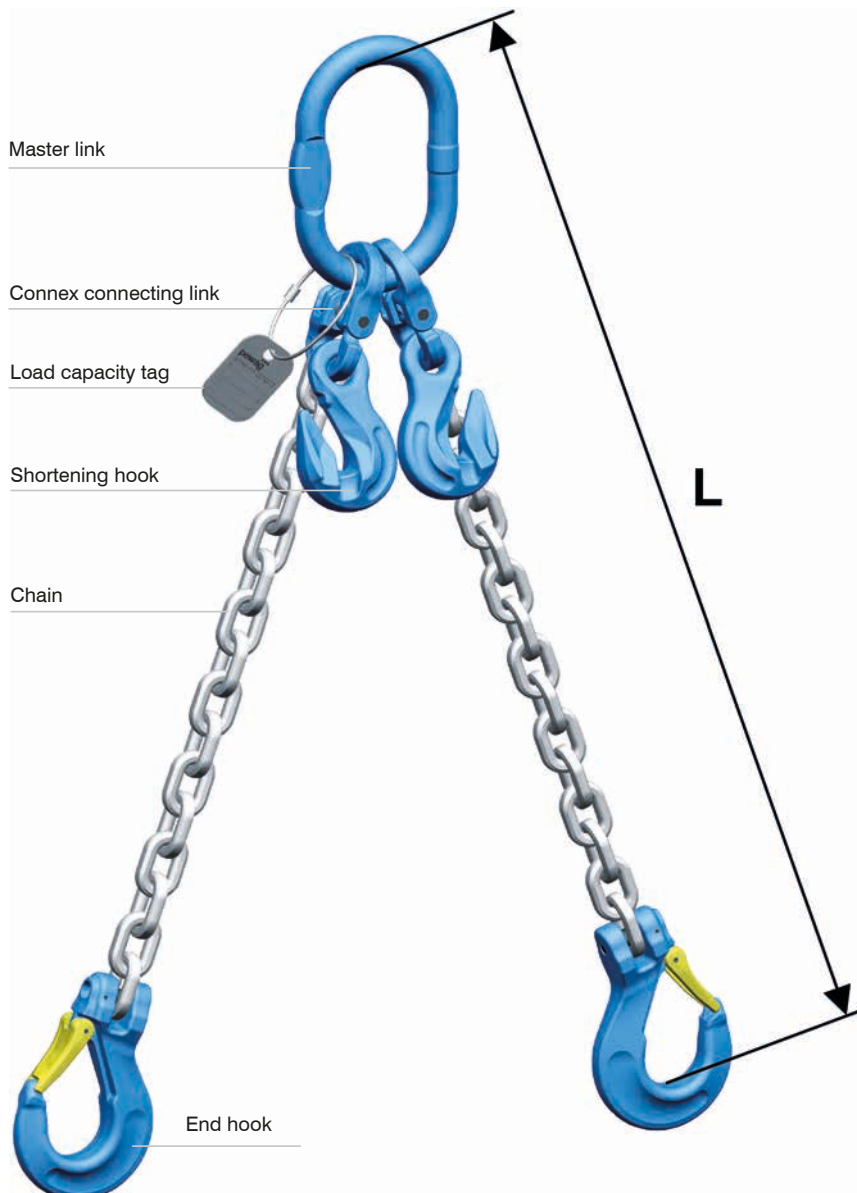

WINPRO 8 FLEX 200 II AWP – KHSWP – PWP 3.500 Connex

Nominal diameter	Number of legs	Master link	End hook	Shortening hook	Length [mm]	Connex mounted
------------------	----------------	-------------	----------	-----------------	-------------	----------------



Load capacities of pewag winner pro

The load capacities as shown in the table are the maximum values of the various sling types, stated according to the standard (Uniform Load) method of rating.

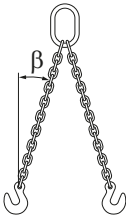
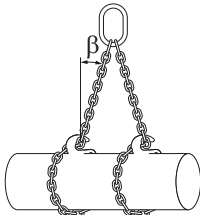
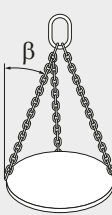
Safety factor 4	I-leg-chains		II-leg-chains		II-leg-chains		III- + IV-leg-chains	
								
Angle of inclination β	-	-	0° – 45°	45° – 60°	0° – 45°	45° – 60°	0° – 45°	
Load factor	1	0.8	1.4	1	1.12	0.8	2.1	
Code	d	Load capacity [kg]						
WINPRO 7	7	2,360	1,900	3,350	2,360	2,650	1,900	5,000
WIN 7	7	1,900	1,500	2,650	1,900	2,120	1,500	4,000
Ni 7 G8	7	1,500	1,200	2,120	1,500	1,700	1,200	3,150
WINPRO 8	8	3,000	2,360	4,250	3,000	3,350	2,360	6,300
WIN 8	8	2,500	2,000	3,550	2,500	2,800	2,000	5,300
Ni 8 G8	8	2,000	1,600	2,800	2,000	2,240	1,600	4,250
WINPRO 10	10	5,000	4,000	7,100	5,000	5,600	4,000	10,600
WIN 10	10	4,000	3,150	5,600	4,000	4,250	3,150	8,000
Ni 10 G8	10	3,150	2,500	4,250	3,150	3,550	2,500	6,700
WINPRO 13	13	8,000	6,300	11,200	8,000	9,000	6,300	17,000
WIN 13	13	6,700	5,300	9,500	6,700	7,500	5,300	14,000
Ni 13 G8	13	5,300	4,250	7,500	5,300	5,900	4,250	11,200
WINPRO 16	16	12,500	10,000	17,500	12,500	14,000	10,000	26,500
WIN 16	16	10,000	8,000	14,000	10,000	11,200	8,000	21,200
Ni 16 G8	16	8,000	6,300	11,200	8,000	9,000	6,300	17,000

If the chain is subjected to extraordinarily severe conditions, the maximum load capacities as listed in the table must be reduced accordingly. Such conditions include high temperatures, asymmetrical loading, edge loading, impact loading etc. In these cases, the load reduction factors as listed on page 20 must be taken into account.



The operating manual also contains information on different conditions and their effects on the load capacities.

III- + IV-leg-chains	IV-leg-chains with load distributor		Endless chain sling	Single lifting sling		Double lifting sling	
45° – 60°	0° – 45°	45° – 60°	-	0° – 45°	45° – 60°	0° – 45°	45° – 60°
1.5	2.8	2	1.6	1.4	1	2.1	1.5
3,550	6,700	4,750	3,750	3,350	2,360	5,000	3,550
2,800	5,300	3,750	3,000	2,650	1,900	4,000	2,800
2,240	4,000	3,000	2,500	2,120	1,500	3,150	2,240
4,500	8,500	6,000	4,750	4,250	3,000	6,300	4,500
3,750	7,100	5,000	4,000	3,550	2,500	5,300	3,750
3,000	5,600	4,000	3,150	2,800	2,000	4,250	3,000
7,500	14,000	10,000	8,000	7,100	5,000	10,600	7,500
6,000	11,200	8,000	6,300	5,600	4,000	8,000	6,000
4,750	8,500	6,300	5,000	4,250	3,150	6,700	4,750
11,800	-	-	12,500	11,200	8,000	17,000	11,800
10,000	-	-	10,600	9,500	6,700	14,000	10,000
8,000	-	-	8,500	7,500	5,300	11,200	8,000
19,000	-	-	20,000	17,500	12,500	26,500	19,000
15,000	-	-	16,000	14,000	10,000	21,200	15,000
11,800	-	-	12,500	11,200	8,000	17,000	11,800

Exceptional conditions – Easily to overcome

Even premium quality products will lose some of their load capacity when exposed to high temperatures, asymmetrical loading, edge loading, shocks or other severe operating conditions. Please refer to the operating manuals if you think that any of these conditions apply.

pewag classifies the following factors as severe conditions:

Temperature range	-60 °C to -40 °C	-40 °C to 200 °C	Above 200 °C to 300 °C	Above 300 °C
Load factor pewag winner pro 200	Not permitted	1	Not permitted	Not permitted
Load factor pewag winner pro 300	1	1	0.6	Not permitted
Asymmetrical distribution of loads	Reduce load capacity by at least 1 chain leg, e.g.: III- or IV-leg chain sling must be treated as II-leg chain sling. If in doubt, work on the assumption that the entire load is carried by a single leg.			
Edge loading*	R = larger than 2 x d*	R = larger than d*	R = d* or smaller	
				
Load factor	1	0.7	0.5	
Shock loading	Light shocks	Moderate shocks	Strong shocks	
Load factor	1	0.7	Not permitted	

* d = Material thickness of the chain



Hardened shell –
intelligent core

peTAG solution

A pewag solution that inspires.

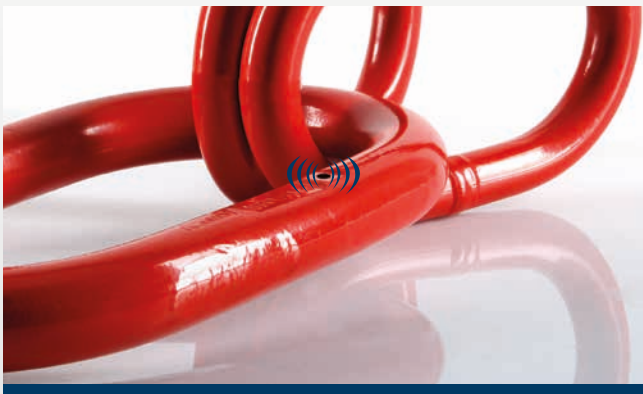

Interested?
peTAG@pewag.com

Chains in G12

Product overview

Content

pewag winner pro 300 lifting chains	24
pewag winner pro 200 lifting chains	25



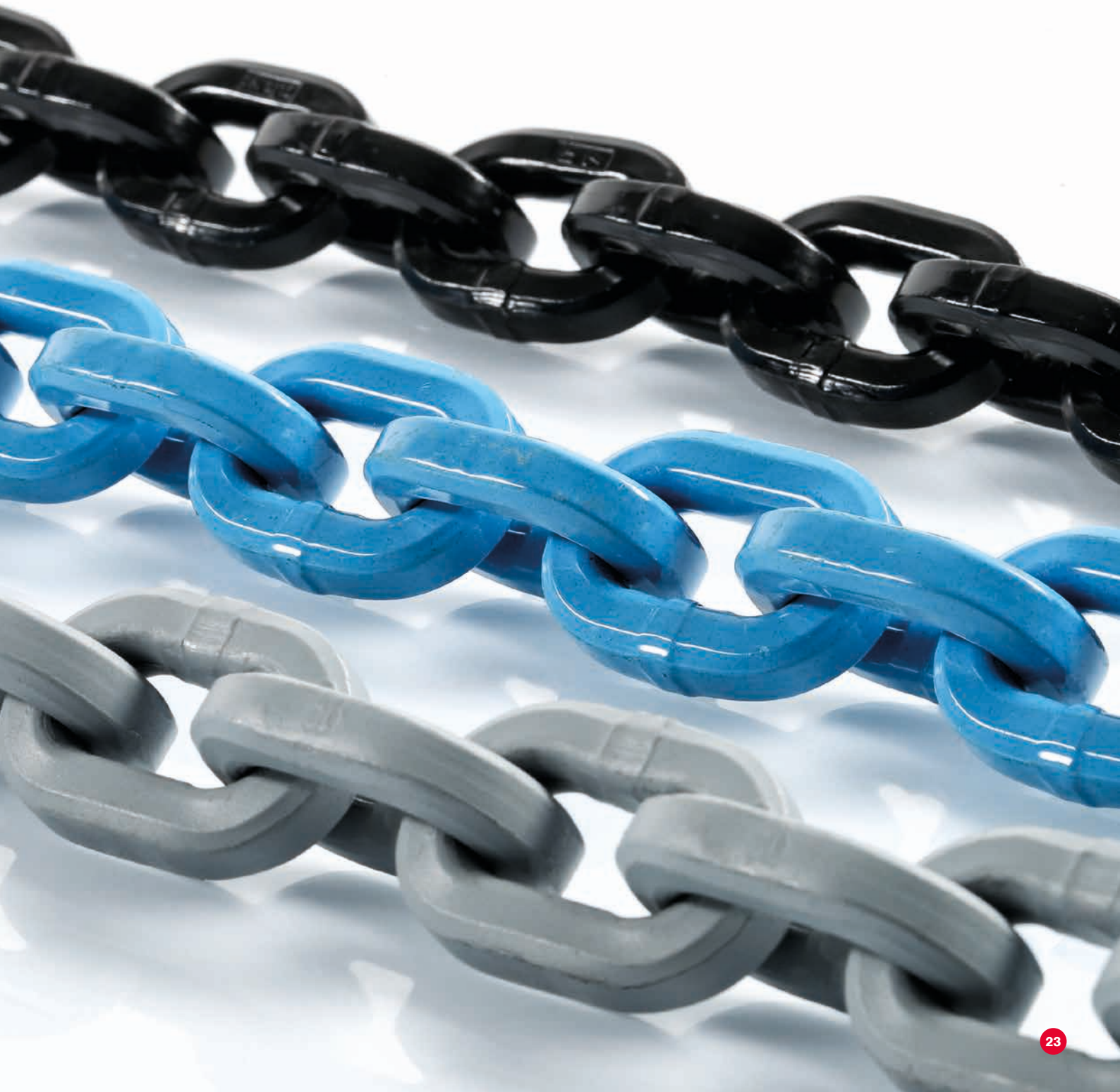

pewag winner pro 300 lifting chains

Taking robustness to a higher level.

This chain has an added load capacity of at least 50 % compared to grade 8 and is manufactured in compliance with PAS 1061 (with modifications). A reduction of the chain dimension and thus also of the weight of the chain sling is possible in almost any application. This high-performance, grade 12 chain comes with BG-approval and also offers added resistance against edge loading thanks to its profile sections. The profiled steel chain in G12 is particularly robust and available with a light blue powder-coated surface and with a black coropro coating.

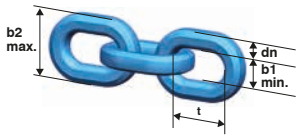
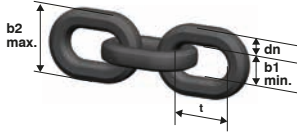

winner pro 300 lifting chains	Code	Nominal diameter dn [mm]	Standard delivery length [m]	Pitch t [mm]	Inside width b1 min. [mm]	Outside width b2 max. [mm]	Load capacity [kg]	Breaking force [kN]	Weight [kg/m]
	WINPRO FLEX 300 PC/B								
	WINPRO 7 FLEX 300	7	50	22	10	26	2,360	92.60	1.36
	WINPRO 8 FLEX 300	8	50	25	11	29	3,000	118	1.64
	WINPRO 10 FLEX 300	10	50	33	14	37	5,000	196	2.70
	WINPRO 13 FLEX 300	13	50	41	19	50	8,000	314	4.80
	WINPRO 16 FLEX 300	16	25	51	23	60	12,500	491	7.17
	WINPRO FLEX 300 PCP								
	WINPRO 7 FLEX 300 PCP	7	50	22	10	26	2,360	92.60	1.36
	WINPRO 8 FLEX 300 PCP	8	50	25	11	29	3,000	118	1.64
	WINPRO 10 FLEX 300 PCP	10	50	33	14	37	5,000	196	2.70
	WINPRO 13 FLEX 300 PCP	13	50	41	19	50	8,000	314	4.80
	WINPRO 16 FLEX 300 PCP	16	25	51	23	60	12,500	491	7.17

pewag winner pro 200 lifting chains

Strong, flexible and efficient.

This new profile steel chain is manufactured according to the mechanical values of G12 and is suitable for a maximum operating temperature of 200 °C. Chamfered corners provide additional flexibility for the chain links and make the chain easier to handle. The chain really comes into its own during choke-hitch applications, due to the reduced impact of edges on the load.

The winner pro Flex 200 chain is available in light grey. Thanks to an improved resistance factor running across the symmetry axis, the chain is more robust when it comes to withstanding deformations in a longitudinal direction compared to round-link chains with the same diameter.

The chain also stands for maximum efficiency as part of the comprehensive winner pro portfolio. A detailed operating manual is available.

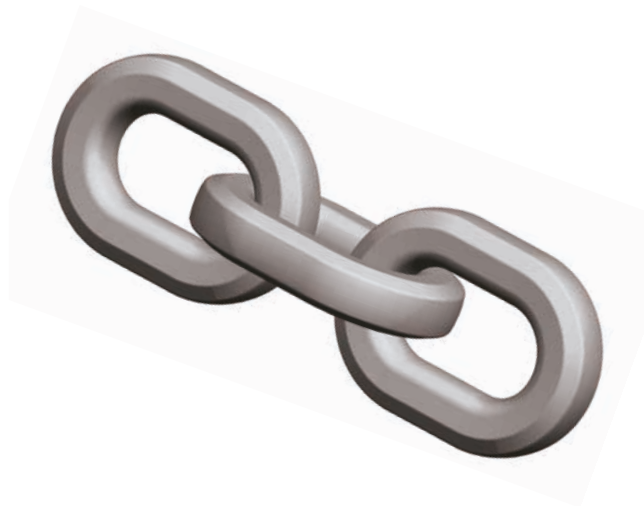

winner pro 200 lifting chains	Code	Nominal diameter d_n [mm]	Standard delivery length [m]	Pitch t [mm]	Inside width b_1 min. [mm]	Outside width b_2 max. [mm]	Load capacity [kg]	Breaking force [kN]	Weight [kg/m]
WINPRO FLEX 200 LAC/GY									
	WINPRO 7 FLEX 200	7	50	22	10	26	2,360	92.60	1.36
	WINPRO 8 FLEX 200	8	50	25	11	29	3,000	118	1.64
	WINPRO 10 FLEX 200	10	50	33	14	37	5,000	196	2.70
	WINPRO 13 FLEX 200	13	50	41	19	50	8,000	314	4.80
	WINPRO 16 FLEX 200	16	25	51	23	60	12,500	491	7.17

Master links and sub-assemblies in G12

Product overview

Content

AWP Master link	28
MWP Enlarged master link	29
VLWP 1 Oversize master link assembly	30
VLWP 2/4 Oversize master link assembly	31
VMWP Enlarged master link assembly	32
ISWP Shortening element – pewag proudly presents	33





pewag AWP Master link

Possibilities galore.

This is a standard master link for creating I- and II-leg chain slings using the CWP Connex connecting links.

Thanks to the flattened sections incorporated in the design, this master link opens up universal connection possibilities and may also be used as an end link with the same classification as for I-leg chain slings. See table for the correct chain dimensions and single hook size according to DIN 15401.

The master link is manufactured in accordance with EN 1677-4 with a load capacity according to G12 and comes with BG-approval. The surface of the master link has a light blue powder coating.



AWP Master link	Code	Load capacity 0°-45° [kg]	Can be used up to single hook according to DIN 15401 no.	d [mm]	t [mm]	w [mm]	s [mm]	Weight [kg/pc.]	For 1-leg slings	For 2-leg slings
	AWP 13	2,360	2.5	13	110	60	10	0.37	7	-
	AWP 16	3,500	2.5	17	110	60	14	0.55	8	7
	AWP 18	5,300	5	19	135	75	14	0.86	10	8
	AWP 22	8,000	6	23	160	90	17	1.60	13	10
	AWP 27	12,500	10	28	200	110	21	2.92	16	13
	AWP 33	17,500	10	33	200	110	21	4.14	-	16

pewag MWP Enlarged master link

What counts, is the inner width.

This master link corresponds to EN 1677-4 with a load capacity according to G12. It is used to create I- and II-leg chain slings using the Connex CWP connecting link and opens up universal connection possibilities thanks to the flattened section incorporated in its design. It may also be used as an end link in single- or multiple-leg chain slings.

With its extra-large inner width compared to the AWP master link, it is also suitable for larger single hooks according to DIN 15401. Refer to the table for the correct chain dimensions and single hook size.

This enlarged master link is manufactured according to EN 1677-4 with the mechanical values of G12 and comes with BG-approval. The surface of the master link has a light blue powder coating.



MWP Enlarged master link	Code	Load capacity [kg]	Can be used up to single hook according to DIN 15401 no.	d [mm]	t [mm]	w [mm]	s [mm]	Weight [kg/pc.]	For 1-leg slings	For 2-leg slings
	MWP 13	2,360	4	14	120	70	10	0.46	7	-
	MWP 16	3,200	5	17	140	80	13	0.74	8	-
	MWP 18	5,000	6	19	160	95	14	1.05	10	-
	MWP 26	10,100	10	27	190	110	20	2.47	13	-
	MWP 36	17,500	10	38	275	150	29	7.48	-	16

pewag VLWP 1 Oversize master link assembly

Optimised for extra strength.

This asymmetrical master link assembly is equipped with extra-large rings that are perfect for crane hooks according to DIN 15401 and up to no. 25. The new design of the upper curve ensures an optimised contact surface on the crane hook. This master link assembly for I-leg chain slings in assembled or welded systems complies with EN 1677-4 and the mechanical values for G12.

The assembly is not just unique when it comes to areas of application, it also comes with CE-marking and a full operating manual.



VLWP 1 Oversize master link assembly	Code	Consisting of	Can be used up to single hook according to DIN 15401 no.	Load capacity [kg]	e [mm]	d [mm]	t [mm]	w [mm]	d1 [mm]	t1 [mm]	w1 [mm]	Weight [kg/pc.]	For 1-leg slings
	VLWP 1-7/8	LWP 22 + BWP 13	25	3,000	394	23	340	155	13	54	25	3.37	7+8
	VLWP 1-10	LWP 26 + BWP 16	25	5,000	410	26	340	155	17	70	34	3.56	10
	VLWP 1-13	LWP 26	25	8,000	340	28	340	155	-	-	-	4.40	13
	VLWP 1-16	LWP 33	25	12,500	340	33	340	155	-	-	-	6.60	16

pewag VLWP 2/4 Oversize master link assembly

Asymmetrically precise.

The new oversize lifting eye stands out for its asymmetrical shape and is suitable for the assembly of II- and IV-leg chain slings, both in the assembled and in the welded system.

The improved design of the upper curve optimises the contact surface of the assembly on the single hook, manufactured according to DIN 15401. The great plus of this master link assembly is the geometry of the lower area, which allows for the simple and quick assessment of the angle of the inclination, thus greatly increasing safety and efficiency during day-to-day operations and making miscalculations a thing of the past.

Extra-large rings make this master link assembly the perfect partner for crane hooks according to DIN 15401 up to no. 25. The assembly comes with CE-marking and is manufactured according to EN 1677-4, with mechanical values according to G12.



VLWP 2/4 Oversize master link assembly	Code	Consisting of	Can be used up to single hook according to DIN 15401 no.	Load capacity 0°-45° [kg]	e [mm]	d [mm]	t [mm]	w [mm]	d1 [mm]	t1 [mm]	w1 [mm]	Weight [kg/pc.]	For 2-leg slings	For 3- and 4-leg slings
	VLWP 2-7/8	LWP 22 + 2 BWP 13	25	4,250	394	23	340	155	13	54	25	3,6	7/8	-
	VLWP 2-10/4-7/8	LWP 26 + 2 BWP 16	25	7,100	410	27	340	155	17	70	34	5,2	10	7/8
	VLWP 2-13/4-10	LWP 32 + 2 BWP 20	25	11,200	425	33	340	155	20	85	40	8,00	13	10
	VLWP 4-13	LWP 36 + 2 BWP 26	25	17,000	480	38	340	155	27	140	65	12,8	-	13
	VLWP 2-16	LWP 36	25	17,500	340	38	340	155	-	-	-	8,9	16	-
	VLWP 4-16	LWP 40 + 2 BWP 32	25	26,500	490	40	340	155	33	150	70	16,3	-	16

pewag VMWP Enlarged master link assembly

True greatness for your load.

A load capacity according to G12, BG-approval and manufacturing according to EN 1677-4 are powerful arguments in favour of this universally usable master link assembly to create II-, III- and IV-leg chain slings for all chain dimensions.

Thanks to the flattened section on the transition links, this IV-leg assembly is also compatible with assembly types other than Connex CWP. The surface of the master link has a light blue powder coating. Refer to the table for the correct chain dimension.

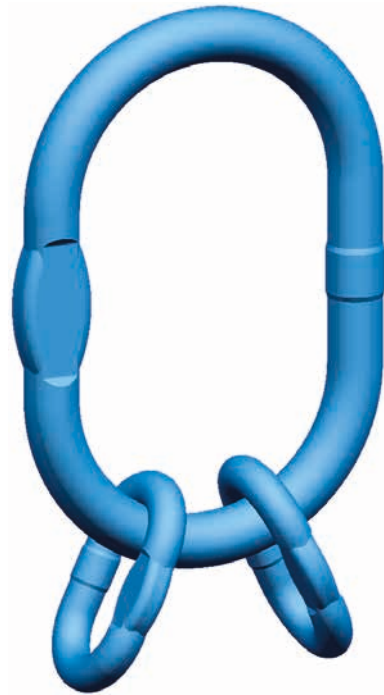

VMWP Enlarged master link assembly	Code	Consisting of	Can be used up to single hook according to DIN 15401 no.	Load capacity 0°-45° [kg]	e [mm]	d [mm]	t [mm]	w [mm]	d1 [mm]	t1 [mm]	w1 [mm]	Weight [kg/pc.]	For 2-leg slings	For 3- and 4-leg slings
	VMWP 7/8	MWP 18 + 2 BWP 13	6	4,250	214	19	160	95	13	54	25	1.47	7+8	-
	VMWP 10/7/8	MWP 26 + 2 BWP 16	10	8,800	260	27	190	110	17	70	34	3.45	10	7+8
	VMWP 13/10	MWP 32 + 2 BWP 20	12	12,300	315	33	230	130	20	85	40	6.28	13	10
	VM-WP -/13	MWP 36 + 2 BWP 26	20	21,200	415	38	275	150	27	140	65	11.50	-	13
	VM-WP -/16	MWP 36 + 2 BWP 32	20	26,500	425	38	275	150	33	150	70	13.80	-	16

pewag proudly presents – ISWP Shortening element

Fast – Simple – Shortened.

- Tool free positioning anywhere along the entire length of the chain
- Possibility to operate it with just one hand
- No need to reduce load capacity
- Available from the end of 2017

pewag sets great store on the further development of its product range and far exceeds market expectations in this respect. A new, innovative shortening element will soon be added to the pewag winner pro portfolio.

The ISWP shortening element is now in the last stages of its development and will be available from the end of 2017. Its outstanding feature will be tool-free positioning anywhere along the entire length of the chain. In addition, it will be possible to operate the shortening element with just one hand, making it even more user-friendly. It will not be necessary to reduce the load capacity when using the shortening element.



Accessories in G12 – Lifting

Product overview

Content

CWP Connex connecting link	36
AGWP Load distributor	37
HSWP Eye sling hook	38
LHWP Safety hook	39
PWP Grab hook	40
KHSWP Clevis sling hook	41
KLHWP Clevis safety hook	42
KPWP Clevis grab hook	43





pewag CWP Connex connecting link

True light blue.

This is a universal connecting link that consists of two die-forged, identical halves, a bolt and a safety sleeve and is manufactured according to EN 1677-1 with a load capacity according to G12. Thanks to the use of a safety sleeve, the design of this connecting link is extremely slim, thereby maximising the use of space – a great advantage compared to competitor products. The links may be assembled and disassembled by a competent person up to three times before the pin and the sleeve must be replaced (both are available as a spare parts set).

BG-approval is just one of the many benefits offered by the CWP Connex connecting link – the simplest way to assemble pewag winner pro chains, master links, master link assemblies and accessory parts. The surface of the master link has a light blue powder coating.



CWP Connex connecting link	Code	Load capacity [kg]	e [mm]	c [mm]	s [mm]	t [mm]	d [mm]	b [mm]	g [mm]	Weight [kg/pc.]
	CWP 7	2,360	63	11.50	13	15.50	9	51	17	0.24
	CWP 8	3,000	62	14	25	20	10	58	20	0.27
	CWP 10	5,000	78	18	21	25	13	66	22	0.57
	CWP 13	8,000	107	22	25	34	17	84	25	1.43
	CWP 16	12,500	128	27	31	41	21	120	48	2.26



pewag AGWP Load distributor

Guaranteed to last the course.

The AGWP load distributor is the perfect partner for the assembly of II- and IV-leg chain slings using Connex connecting links. It fulfils all the requirements of standard load distributors as well as ensuring an optimised force balance. The significantly improved load distribution allows for a higher load capacity (at least 30 % with equal dimensions) as all legs of the chain sling are placed under the same load.

In IV-leg chain slings, the AGWP makes it possible to consider all four chains as load-bearing. If two II-leg chain slings are used and one of them is equipped with a load distributor, this system may also be used as a IV-leg chain sling with four load-bearing legs. The extremely flat design also makes it possible to use the load distributor with an angle of inclination of up to 60°.

If elimination criteria apply, the load distributor may be rotated by 180°, thereby effectively doubling its lifespan. The full operating manual contains detailed information on this long-lasting product.

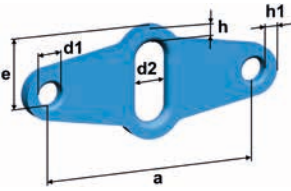

AGWP Load distributor	Code	Connec- ting link	Load capacity 0°-45° [kg]	Load capacity 45°-60° [kg]	a [mm]	e [mm]	d1 [mm]	d2 [mm]	h [mm]	h1 [mm]	s [mm]	Dif- ference L1/L2 [chain links]	Weight [kg/pc.]
	AGWP 7/8	CWP 10	4,250	3,000	210	51	22	25	15.50	14	15	6 for 7 mm chain, 5 for 8 mm chain	1.75
	AGWP 10	CWP 13	7,100	5,000	180	32	25	32	23	15.50	15	4	1.56

Please use the displayed item in column "Connecting link" to assemble the load distributor in the four-leg sling.
Static test coefficient = 2.5 x load capacity of the respective chain section; safety factor = 4



Video AGWP

pewag[®] HSWP Eye sling hook

Better to wear out than to rust out.

This eye sling hook is universally usable and comes with a forged and galvanised safety catch that locks into the tip of the hook, thereby providing excellent protection against lateral shifts.

The safety catch with a latch, the safety pin and the stainless spring are available as a spare parts set for each hook and easy and quick to replace by a competent person.

The hook is manufactured according to EN 1677-2 with the mechanical values of G12, comes with BG-approval and a light blue powder coating. The combination of the HSWP eye sling hook and the pewag winner pro connex system simply can't be beaten.



HSWP Eye sling hook	Code	Load capacity [kg]	e [mm]	h [mm]	a [mm]	d1 [mm]	d2 [mm]	g1 [mm]	b [mm]	Weight [kg/pc.]
	HSWP 7/8	3,000	106	27	19	25	11	26	88	0.65
	HSWP 10	5,000	131	33	26	34	16	31	108	1.29
	HSWP 13	8,000	164	43	33	43	19	39	132	2.43

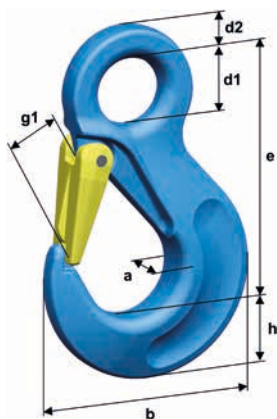

pewag LHWP Safety hook

Safety first.

This safety hook corresponds to EN 1677-3 with a load capacity according to G12 and closes and locks automatically when placed under load, thereby offering even greater safety.

Thanks to the larger jaw size compared to the HSWP eye sling hook, this safety hook offers greater flexibility when it comes to possible combinations with the pewag winner pro Connex system.

The surface of the safety hook has a light blue powder coating. The hook may only be opened when it is not under load.

The locking set on the back of the hook consists of a lever, safety pin and stainless spring and is also available as a spare parts set. The parts are quick and easy to replace by a competent person. The hook also comes with BG-approval.



LHWP Safety hook	Code	Load capacity [kg]	e [mm]	h [mm]	a [mm]	b [mm]	d1 [mm]	d2 [mm]	g1 [mm]	s max. [mm]	Weight [kg/pc.]
	LHWP 7/8	3,000	126	25	25	89	25	14	34	1	0.91
	LHWP 10	5,000	158	31	28	112	31	17	45	1.50	1.56
	LHWP 13	8,000	205	41	34	145	40	22	54	2	3.50

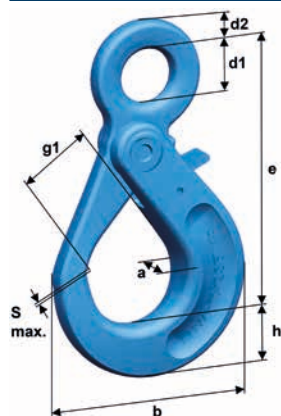

pewag PWP Grab hook

Perfect for chains and slings.

The standard shortening hook with BG-approval in the G12 programme is perfect both for the Connex and the welded system. A reduction of the load capacity when shortened is not required for this hook. Another great plus of this product is that it can be retrofitted into the system.

The hook corresponds to EN 1677-1 with the load capacity of G12 and is also available with a safety mechanism to prevent the accidental unhooking of the chain. Please see the lashing section for more information. The grab hook is suitable for the shortening of chains and the forming of slings that must not tighten.



PWP Grab hook	Code	Load capacity [kg]	e [mm]	b [mm]	d1 [mm]	d2 [mm]	g1 [mm]	Weight [kg/pc.]
	PWP 7/8	3,000	68	63	18	11	10	0.51
	PWP 10	5,000	88	81	22	14	13	1.04
	PWP 13	8,000	110	103	26	18	17	2.19

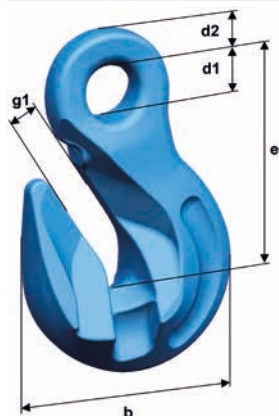

pewag KHSWP Clevis sling hook

Resistance on a large scale.

This is a completely new hook in the pewag winner pro G12 range with a considerably larger jaw size than the HSWP eye sling hook.

It is manufactured according to EN 1677-2 with the mechanical values of grade 12 and may be mounted directly into the chain in the pewag winner pro clevis system without the need for a connecting link. The forged safety catch locks into the tip of the hook, thereby providing excellent protection against lateral shifts. The safety catch mechanism and the clevis load pins are available as spare parts set and easy and quick to exchange by a competent person.

The forged control markings make it easy to determine discard criteria.

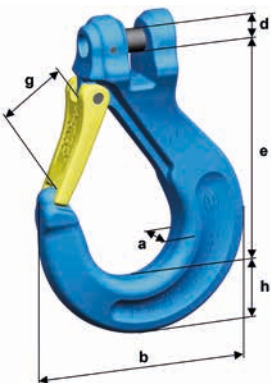

KHSWP Clevis sling hook	Code	Load capacity [kg]	e [mm]	h [mm]	a [mm]	d [mm]	g1 [mm]	b [mm]	Weight [kg/pc.]
	KHSWP 7	2,360	105	26	19	9.50	36	101	0.85
	KHSWP 8	3,000	105	26	19	10.70	36	101	0.85
	KHSWP 10	5,000	121	33	26	14	41	118	1.68
	KHSWP 13	8,000	148	43	30	17.50	49	147	2.99
	KHSWP 16	12,500	173	51	35	21	59	176	5.10

pewag KLHWP Clevis safety hook

Specialises in: safety and strength.

The great advantage of this clevis safety hook is that it closes and locks automatically under load, thereby preventing unintentional opening and providing additional safety during day-to-day operations. The larger jaw opening compared to the HSWP clevis hook provides additional versatility and flexibility.

The clevis safety hook is manufactured according to EN 1677-3 with mechanical values for G12. The hook is suitable for straight pull only. Tip loading of the hook or loading of the safety catch are not permissible. The hook is easy to assemble and does not require special tools or additional connecting links as it is placed directly in the chain. Please note that assembly must be performed by a competent person. The full operating manual contains detailed instructions on the correct use of the product.

The hook comes with CE-marking and exchangeable spare parts. The coupling pin and safety pin are available as a KBSWP spare parts set, as is the VLHWP locking set on the back of the hook.



KLHWP Clevis safety hook	Code	Load capacity [kg]	e [mm]	h [mm]	a [mm]	b [mm]	d [mm]	g [mm]	s max. [mm]	Weight [kg/pc.]
	KLHWP 7	2,360	116	24.50	23.60	90	9.50	32	1	0.89
	KLHWP 8	3,000	115	24.50	23.60	90	10.70	32	1	0.90
	KLHWP 10	5,000	136	31.50	27.80	113	14	45	1	1.60
	KLHWP 13	8,000	179	39.80	33.70	146	17.50	54	1.50	3.42

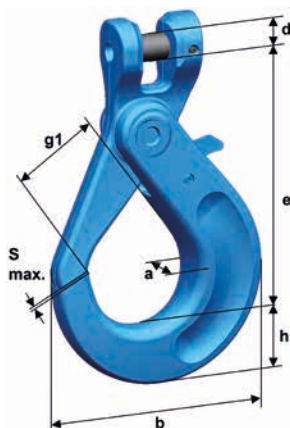

pewag KPWP Clevis grab hook

Perfect for chains and slings.

The standard shortening hook with BG-approval in the G12 programme is perfect both for the Connex and the welded system. A reduction of the load capacity when shortened is not required for this hook. Another great plus of this product is that it can be retrofitted into the system.

The hook corresponds to EN 1677-1 with the load capacity of G12 and is also available with a safety mechanism to prevent the accidental unhooking of the chain. Please see the lashing section for more information. The grab hook is suitable for the shortening of chains and the forming of slings that must not tighten.



KPWP Clevis grab hook	Code	Load capacity [kg]	e [mm]	b [mm]	d [mm]	g1 [mm]	Weight [kg/pc.]
	KPWP 16	12,500	124	123	21	19	4.32

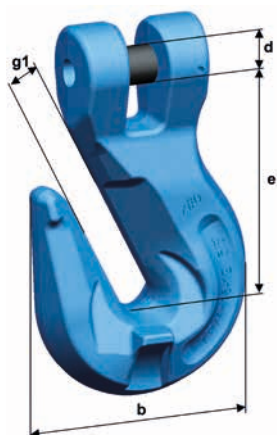

pewag winner pro

Lashing in G12

Benefits and information

Content

Benefits, labelling	46
Key data, sample order	47
Table for direct lashing	48
Table for frictional lashing	49

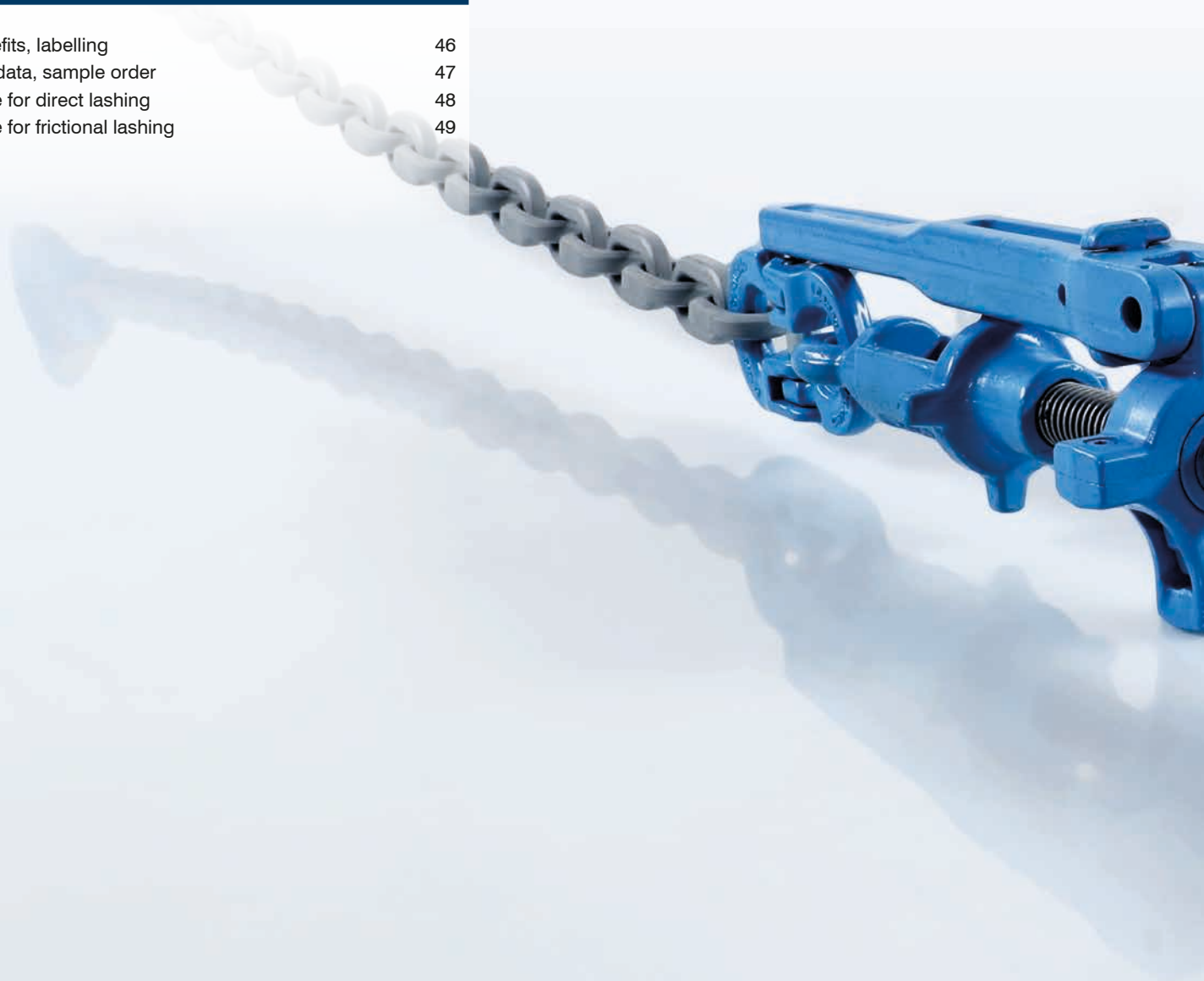



pewag lashing chains in G12 quality – benefits that speak for themselves

pewag is deservedly proud of its pioneering role when it comes to the production of lashing chains. The pewag name rests on outstanding quality features that are also the core element of our G12 programme: The 50 % increase in the lashing capacity with our G12 range compared to standard G8 programmes results in a significant weight reduction that gives rise to numerous advantages in daily lashing operations. Ease-of-use and compliance with all legal stipulations are par for the course and the rock-solid foundation out of which all our products grow. But our G12 products are still capable of more: The specially developed chain profile leads to a markedly improved bending resistance, which is particularly helpful when loading the chain over a corner.

- Intelligent profile:** Thanks to the intelligent use of material, the same cross-section achieves a marked improvement of the key characteristics of the chain, for instance fatigue resistance and bending resistance, compared to conventional round-steel chains. The use of material was optimised in key areas (blue sections) and reduced in less relevant areas (red sections) to achieve the best possible technical effects
 

- Optimised bending resistance:** This crucial resistance factor that protects the chain from undesirable bending is up to 6 % higher with the profile chain compared to a round-link chain with the same cross-section. This reduces the maximum tension in the chain (no red sections)
 

Die Vorteile im Überblick:

- 50 % increase in lashing capacity** and therefore also in load-securing capacity compared to G8

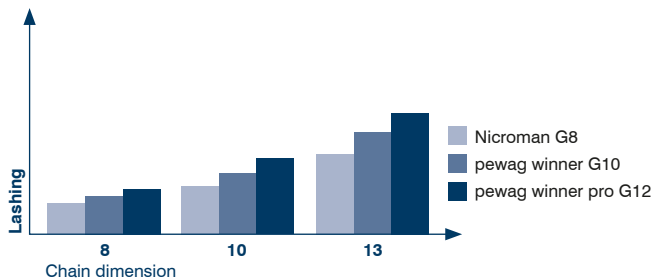

- The same chain dimension** secures a heavier or bigger load – no less than a 50 % increase compared to lashing in G8 and a 20 % increase compared to G10!

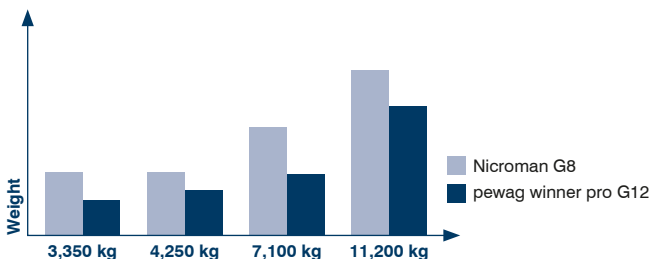

Admissible lashing capacity LC	Weight of chain up to now	pewag winner pro chain weight	% reduction
60	14.50	10.30	29 %
100	26.10	15.60	40 %
160	37.70	30.70	18 %

- Part of the pewag winner pro range: **a 7 mm chain**
- Optimised strength and toughness characteristics at high and low temperatures thanks to **patented material**
- Significant improvements for **direct lashing: Chain dimension is reduced**, resulting in significantly lower weight and costs! Example: 8 mm G12 (LC = 60 kN) replaces 10 mm G8 (LC = 63 kN)

Admissible lashing capacity LC	chains up to ø	pewag winner pro chain-ø
60	10	8
100	13	10
160	16	13

- Lashing-down operations: chain dimension is reduced** in G12 while the load-securing capacity (STF) remains the same, resulting in significantly lower weight and costs!
- Lashing operations using pewag winner pro result in **significantly reduced weight** and easier handling
- Maximum safety** thanks to special lashing tag made from rust-resistant material with separate area for regular inspection data entry

Identification of the pewag winner pro lashing tags

pewag once more lives up to its reputation: our products comply with the highest safety standards and constitute true innovations on the international market. The specially designed lashing tags made from rust-resistant material with a separate area for regular inspection data entry ensure a longer lifespan compared to conventional lashing tags. This increases the safety of the entire lashing chain – yet another pewag speciality!



pewag winner pro key data – facts that speak for themselves

Top of the range:

- **Chain qualities:**
pewag WINPRO FLEX 200 – based on EN 818-2 with modifications (profile, higher load capacity, reduced operating temperature)
- **Test stress:** 750 N/mm²
- **Breaking stress:** 1,200 N/mm²
- **Breaking elongation:** min. 20 %
- **Bending according EN 818-2 or PAS 1061:** 0.8 x d
- **Admissible operating temperature:**
pewag WINPRO FLEX 200: -40 °C – 200 °C
- **Quality grade stamping**
pewag WINPRO FLEX 200: „PEWAG12“ / „200“ on every 20th link and 12 on the back of each link
Components: 12

- **Manufacturer's name or symbol:** D16 and/or pewag
- **Surface:**
pewag WINPRO FLEX 200: light grey coating
Components: light blue powder-coating
- **Lashing tag:** Shows required data according EN12195-3
- **Compatibility:**
Please note that the compatibility of pewag winner pro chains and components with those of other grades and from other manufacturers is limited! For this reason, any combinations shall be approved by pewag in advance.

All dimensions in this catalog are nominal dimensions
Depending on the manufacturing process they are subject to various manufacturing tolerances.
Please contact our customer service if required.

Sample order for pewag winner pro lashing

Below you will find a detailed example of an order for a finished and commercially available pewag lashing chain: pewag winner 8 mm – single lashing chain with shortening components and clevis hook, mounted with Connex connecting links (length: 3,500 mm).

ZRSKWP 8 FLEX 200 | KHSWP – KHSWP – PSWP 3500

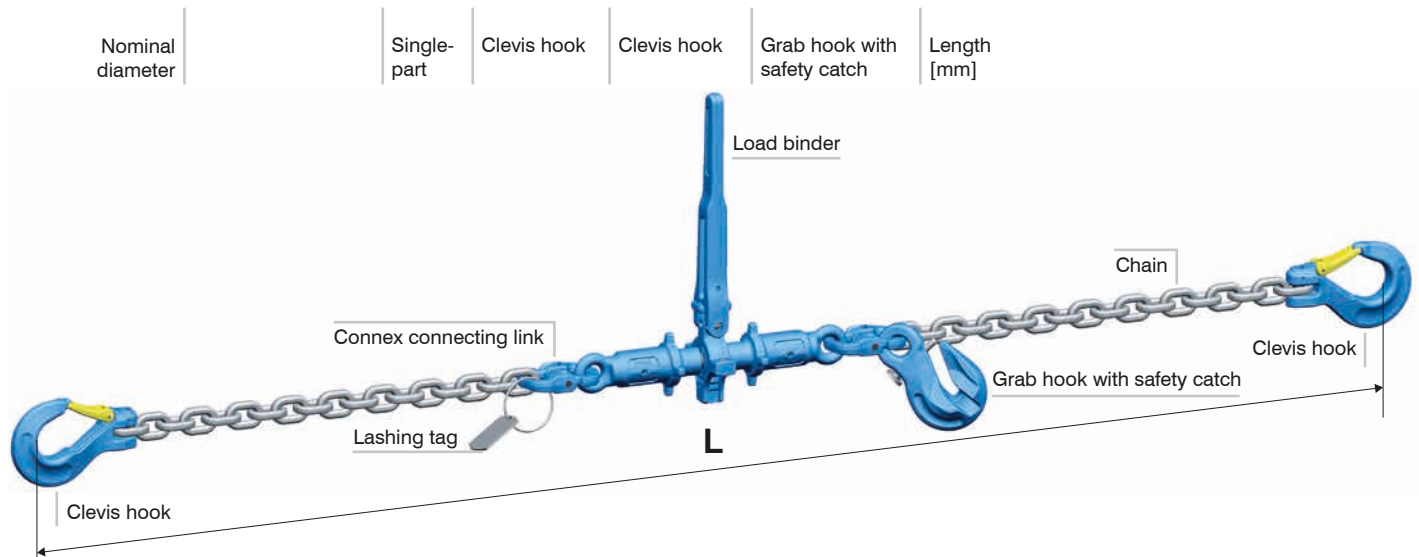

Direct lashing

Lashing system: WINPRO 7 chain with load binder dimension 7 (LC 47 kN; for 4 lashing chains)

Angle α	Angle β	Max. load at dynamic friction factor						
		0.01	0.1	0.2	0.3	0.4	0.5	0.6
20 - 35°	21 - 30°	-	-	10,150	13,700	16,550	20,400	25,950
20 - 35°	31 - 40°	7,450	8,650	10,300	12,350	15,000	18,600	23,450
20 - 35°	41 - 50°	6,250	7,350	8,850	10,700	13,100	16,150	20,350
20 - 35°	51 - 60°	4,900	5,850	7,150	8,800	10,750	13,200	16,750
36 - 50°	21 - 30°	-	-	9,250	11,900	14,750	18,650	24,200
36 - 50°	31 - 40°	-	7,100	8,750	10,850	13,550	17,200	22,450
36 - 50°	41 - 50°	4,950	6,100	7,600	9,550	12,050	15,450	20,350
36 - 50°	51 - 60°	-	4,900	6,300	8,050	10,350	13,450	17,850

Lashing system: winner pro 8 chain with load binder dimension 8 (LC 60 kN; for 4 lashing chains)

Angle α	Angle β	Max. load at dynamic friction factor						
		0.01	0.1	0.2	0.3	0.4	0.5	0.6
20 - 35°	21 - 30°	-	-	13,000	17,450	21,150	26,100	33,150
20 - 35°	31 - 40°	9,550	11,050	13,150	15,750	19,150	23,750	29,950
20 - 35°	41 - 50°	8,000	9,400	11,300	13,650	16,750	20,650	25,950
20 - 35°	51 - 60°	6,250	7,450	9,100	11,200	13,700	16,850	21,350
36 - 50°	21 - 30°	-	-	11,800	15,200	18,850	23,800	30,900
36 - 50°	31 - 40°	-	9,100	11,200	13,850	17,300	22,000	28,700
36 - 50°	41 - 50°	6,300	7,750	9,700	12,200	15,400	19,750	25,950
36 - 50°	51 - 60°	-	6,250	8,050	10,300	13,200	17,150	22,800

Lashing system: WINPRO 10 chain with load binder dimension 10 (LC 100 kN; for 4 lashing chains)

Angle α	Angle β	Max. load at dynamic friction factor						
		0.01	0.1	0.2	0.3	0.4	0.5	0.6
20 - 35°	21 - 30°	-	-	21,650	29,150	35,250	43,500	55,250
20 - 35°	31 - 40°	15,900	18,450	21,950	26,300	31,950	39,650	49,900
20 - 35°	41 - 50°	13,350	15,700	18,800	22,800	27,900	34,450	43,300
20 - 35°	51 - 60°	10,400	12,450	15,200	18,700	22,850	28,100	35,600
36 - 50°	21 - 30°	-	-	19,700	25,350	31,450	39,700	51,500
36 - 50°	31 - 40°	-	15,150	18,650	23,100	28,850	36,650	47,800
36 - 50°	41 - 50°	10,550	12,950	16,200	20,350	25,700	32,950	43,300
36 - 50°	51 - 60°	-	10,450	13,400	17,150	22,000	28,600	38,050

Lashing system: WINPRO 13 chain with load binder dimension 13 (LC 160 kN; for 4 lashing chains)

Angle α	Angle β	Max. load at dynamic friction factor						
		0.01	0.1	0.2	0.3	0.4	0.5	0.6
20 - 35°	21 - 30°	-	-	34,700	46,650	56,400	69,600	88,450
20 - 35°	31 - 40°	25,500	29,550	35,100	42,100	51,150	63,400	79,850
20 - 35°	41 - 50°	21,400	25,100	30,150	36,450	44,700	55,100	69,250
20 - 35°	51 - 60°	16,700	19,950	24,350	29,950	36,600	45,000	57,000
36 - 50°	21 - 30°	-	-	31,550	40,550	50,300	63,500	82,400
36 - 50°	31 - 40°	-	24,250	29,850	36,950	46,200	58,700	76,500
36 - 50°	41 - 50°	16,900	20,750	25,950	32,550	41,150	52,700	69,250
36 - 50°	51 - 60°	-	16,700	21,450	27,450	35,250	45,800	60,900

This table provides information on how to get the best use from the pewag lashing systems. The loads specified are maximum loads that may be secured using four equal lashing chains and given the specified angles and dynamic friction factors. Additional securing methods (i.e. wedges or similar) that may be used to secure even heavier weights have not been taken into account. Please contact our customer service for more information. Every pewag lashing product has its own table. The maximum forces resulting from acceleration, braking and avoidance manoeuvres in road traffic acc. to EN 12195-1 were taken into account. Different tables apply for transport by rail and sea. Our customer service team will be pleased to provide additional information.

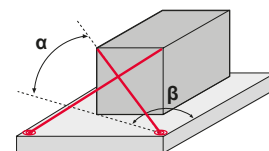

Frictional lashing

Load binder with STF of: 1900 daN

Angle to loading surface α	Max. load/chain with dynamic friction factor					
	0.1	0.2	0.3	0.4	0.5	0.6
90	430	1.010	1.820	3.040	5.060	9.120
85	430	1.000	1.810	3.020	5.040	9.080
80	420	990	1.790	2.990	4.980	8.980
70	400	950	1.710	2.850	4.760	8.560
60	370	870	1.570	2.630	4.380	7.890
50	330	770	1.390	2.320	3.880	6.980
40	270	650	1.170	1.950	3.250	5.860
30	210	500	910	1.520	2.530	4.560

Load binder with STF of: 2200 daN

Angle to loading surface α	Max. load/chain with dynamic friction factor					
	0.1	0.2	0.3	0.4	0.5	0.6
90	500	1.170	2.110	3.520	5.860	10.560
85	500	1.160	2.100	3.500	5.840	10.510
80	490	1.150	2.070	3.460	5.770	10.390
70	470	1.100	1.980	3.300	5.510	9.920
60	430	1.010	1.820	3.040	5.080	9.140
50	380	890	1.610	2.690	4.490	8.080
40	320	750	1.350	2.260	3.770	6.780
30	250	580	1.050	1.760	2.930	5.280

Load binder with STF of: 2500 daN

Angle to loading surface α	Max. load/chain with dynamic friction factor					
	0.1	0.2	0.3	0.4	0.5	0.6
90	570	1.330	2.400	4.000	6.660	12.000
85	560	1.320	2.390	3.980	6.640	11.950
80	560	1.310	2.360	3.930	6.560	11.810
70	530	1.250	2.250	3.750	6.260	11.270
60	490	1.150	2.070	3.460	5.770	10.390
50	430	1.020	1.830	3.060	5.100	9.190
40	360	850	1.540	2.570	4.280	7.710
30	280	660	1.200	2.000	3.330	6.000

Load binder with STF of: 3000 daN

Angle to loading surface α	Max. load/chain with dynamic friction factor					
	0.1	0.2	0.3	0.4	0.5	0.6
90	680	1.600	2.880	4.800	8.000	14.400
85	680	1.590	2.860	4.780	7.960	14.340
80	670	1.570	2.830	4.720	7.870	14.180
70	640	1.500	2.700	4.510	7.510	13.530
60	590	1.380	2.490	4.150	6.920	12.470
50	520	1.220	2.200	3.670	6.120	11.030
40	440	1.020	1.850	3.080	5.140	9.250
30	340	800	1.440	2.400	4.000	7.200

This table provides information on how to get the best use from the pewag lashing systems. The loads specified are maximum loads that may be secured using four equal lashing chains and given the specified angles and dynamic friction factors. Important: Use at least two lashing devices for lashing-down operations! Additional securing methods (i.e. wedges, using the side panel as a blocker etc.) that may be used to secure even heavier weights have not been taken into account in the table. Please contact our customer service for more information.

The values specified in the table only apply to situations where the lashing system on both sides of the load is not subject to the same tension force (STF) due to the deflection and edges. If this can be determined (e.g. using a pretensioning gauge), the values in the table may be increased by a factor of 1,3. The maximum loading weight depends on the STF value of the tensioning system, which is shown on the lashing system's tag.

Every lashing system has its own table. The maximum forces resulting from acceleration, braking and avoidance manoeuvres in road traffic acc. to EN 12195-1 were taken into account. Different tables apply for transport by rail and sea. Our customer service team will be pleased to provide additional information.

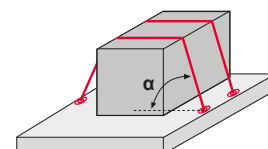

Accessories in G12 – Lashing

Product overview

Content

pewag winner pro 200 lashing chains	52
CWP Connex connecting link	53
HSWP Eye sling hook	54
KHSWP Clevis sling hook	55
PSWP Grab hook	56
RSWP Load binder	57
RSKWP Load binder	58
Comparison between pewag G8, G10 and G12 lashing chains	58
RSPSWP Load binder	59
ZRSWP HSWP – HSWP – PSWP Lashing chain	60
ZRSWP KHSWP – KHSWP – PSWP Lashing chain	61
ZKWP HSWP – HSWP Lashing chain	62
ZKWP KHSWP – KHSWP Lashing chain	63



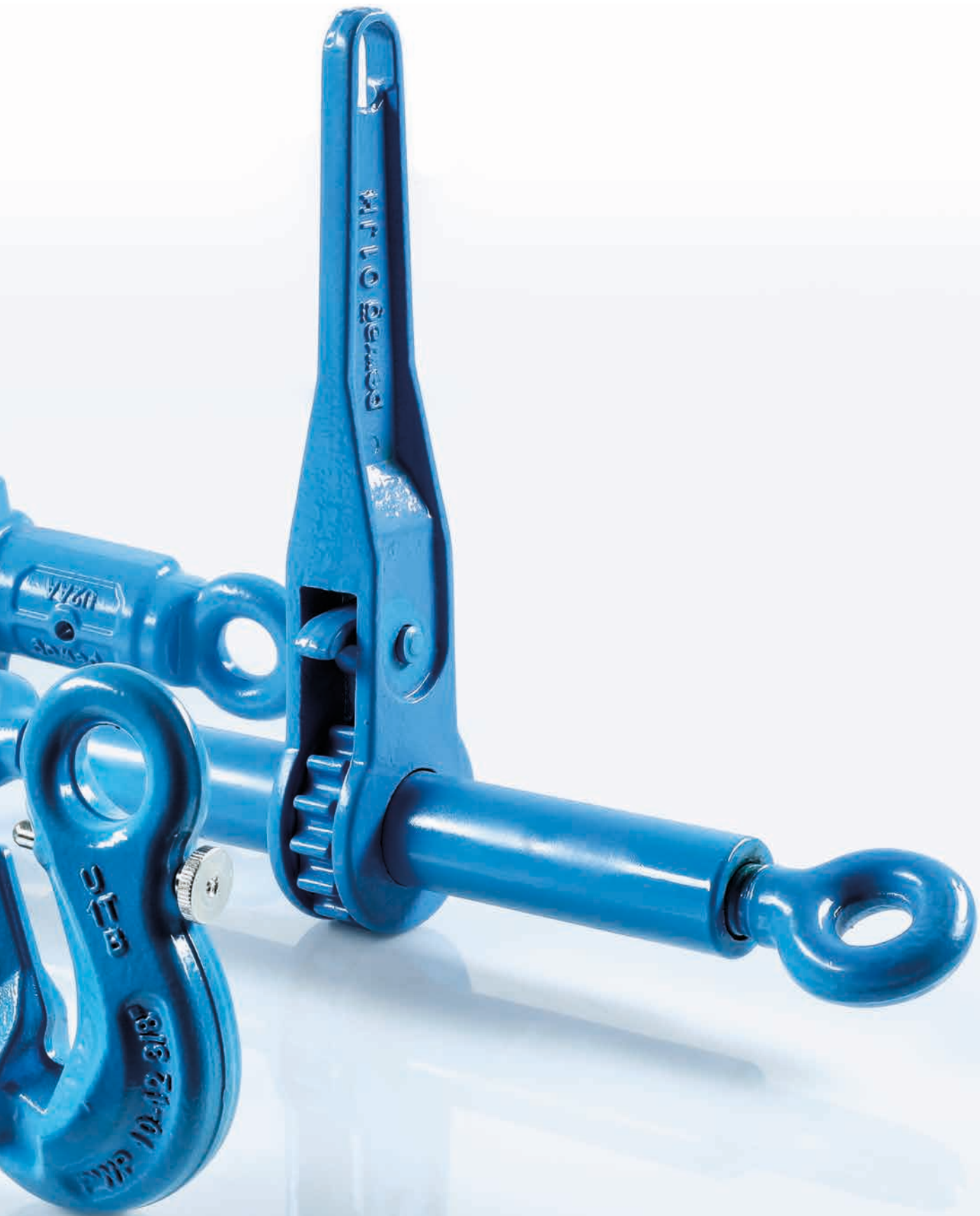

pewag winner pro 200 lashing chains

Lashing with the utmost care.

This lashing chain complies with EN 12195-3 with the mechanical values of G12 and a 50 % higher lashing capacity than grade 8. It is used to assemble lashing systems in a single- or two-part system according to EN 12195-3 and is suitable for operating temperatures from -40 °C to +200 °C.

The chamfered corners of this intelligent profile chain improve the flexibility of the individual chain links and are particularly gentle on the load. The chain is quick and easy to assemble using the Connex or clevis system. A detailed operating manual is available.



winner pro 200 lashing chains	Code	Nominal diameter dn [mm]	Standard delivery length [m]	Pitch t [mm]	Inside width b1 min. [mm]	Outside width b2 max. [mm]	LC lashing capacity [kN]	Breaking force [kN]	Weight [kg/m]
WINPRO FLEX 200 LAC/GY									
	WINPRO 7 FLEX 200	7	50	22	10	26	47	92.60	1.36
	WINPRO 8 FLEX 200	8	50	25	11	29	60	118	1.64
	WINPRO 10 FLEX 200	10	50	33	14	37	100	196	2.70
	WINPRO 13 FLEX 200	13	50	41	19	50	160	314	4.80
	WINPRO 16 FLEX 200	16	25	51	23	60	-	491	7.17

pewag CWP Connex connecting link

True light blue.

The Connex connecting link G12 corresponds to EN 1677-1 with the lashing capacity of G12 and may be used as a universal connecting link for the simple assembly of pewag winner pro lashing chains. It comes with BG-approval, consists of two die-forged, identical halves, a bolt and a safety sleeve. The surface of the master link has a light blue powder coating.

Thanks to the use of a safety sleeve, the design of this connecting link is extremely slim, thereby maximising the use of space – a great advantage for pewag on the market! The links may be mounted and dismantled by a competent person up to three times before the pin and the sleeve must be replaced (both are available as a spare parts set).



CWP Connex connecting link	Code	LC Lashing capacity [kN]	e [mm]	c [mm]	s [mm]	t [mm]	d [mm]	b [mm]	g [mm]	Weight [kg/pc.]
	CWP 7	47	63	11.50	13	15.50	9	51	17	0.24
	CWP 8	60	62	14	25	20	10	58	20	0.27
	CWP 10	100	78	18	21	25	13	66	22	0.57
	CWP 13	160	107	22	25	34	17	84	25	1.43



pewag[®] HSWP Eye sling hook

Better to wear out than to rust out.

This eye sling hook is ideally suited for the pewag winner pro Connex system. It is universally usable and comes with a forged and galvanised safety catch that locks into the tip of the hook, thereby providing excellent protection against lateral shifts. The safety catch with a latch, the safety pin and the stainless spring are available as a spare parts set for each hook and easy and quick to replace by a competent person.

The hook is manufactured according to EN 1677-2 with the mechanical values of G12, comes with BG-approval and a light blue powder coating.



HSWP Eye sling hook	Code	LC Lashing capacity [kN]	e [mm]	h [mm]	a [mm]	d1 [mm]	d2 [mm]	g1 [mm]	b [mm]	Weight [kg/pc.]
	HSWP 7/8	60	106	27	19	25	11	26	88	0.65
	HSWP 10	100	131	33	26	34	16	31	108	1.29
	HSWP 13	160	164	43	33	43	19	39	132	2.43

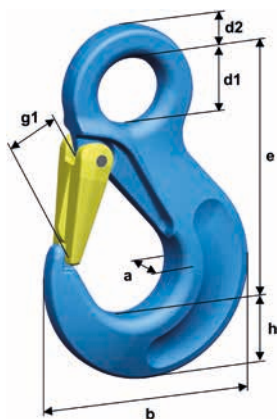

pewag KHSWP Clevis sling hook

Resistance on a large scale.

This is a completely new hook in the pewag winner pro G12 range with a considerably larger jaw size than the HSWP eye sling hook.

It is manufactured according to EN 1677-2 with the mechanical values of grade 12 and may be mounted directly into the chain in the pewag winner pro clevis system without the need for a connecting link. The forged safety catch locks into the tip of the hook, thereby providing excellent protection against lateral shifts. The safety catch mechanism and the clevis load pins are available as spare parts sets and easy and quick to exchange by a competent person.

The forged control markings make it easy to determine discard criteria.



KHSWP Clevis sling hook	Code	LC Lashing capacity [kN]	e [mm]	h [mm]	a [mm]	d [mm]	g1 [mm]	b [mm]	Weight [kg/pc.]
	KHSWP 7	47	105	26	19	9.50	36	101	0.85
	KHSWP 8	60	105	26	19	10.70	36	101	0.85
	KHSWP 10	100	121	33	26	14	41	118	1.68
	KHSWP 13	160	148	43	30	17.50	49	147	2.99

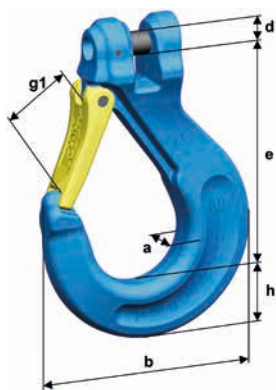

pewag PSWP Grab hook

Short and safe.

This grab hook for the winner pro Connex system is the standard shortening hook with a safety bolt in the G12 lashing programme. The hook prevents the accidental release of the chain.

The special design of the chain contact fosters the ideal interplay between the chain and the hook – and it is not necessary to reduce the admissible lashing capacity when shortened.

The hook is manufactured according to EN 1677-1 with the lashing capacity of G12 and is visually striking thanks to its light blue, powder-coated surface.



PSWP Grab hook	Code	LC Lashing capacity [kN]	e [mm]	b [mm]	d1 [mm]	d2 [mm]	g1 [mm]	Weight [kg/pc.]
	PSWP 7/8	60	68	63	18	11	10	0.53
	PSWP 10	100	88	81	22	14	13	1.05
	PSWP 13	160	110	103	26	18	17	1.89

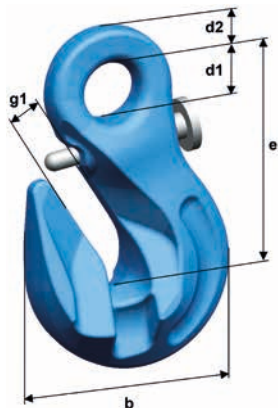

pewag[®] RSWP Load binder

Get some leverage.

This universal load binder with an optimised lever length for one- and two-part lashing chain systems is suitable for direct lashing as well as for lashing down in the pewag winner pro Connex system and corresponds to EN 12195-3 with the lashing capacity of G12.

Please refer to the tables for the correct selection of load binders and accessories, taking into account the load to be secured and the local operating conditions.

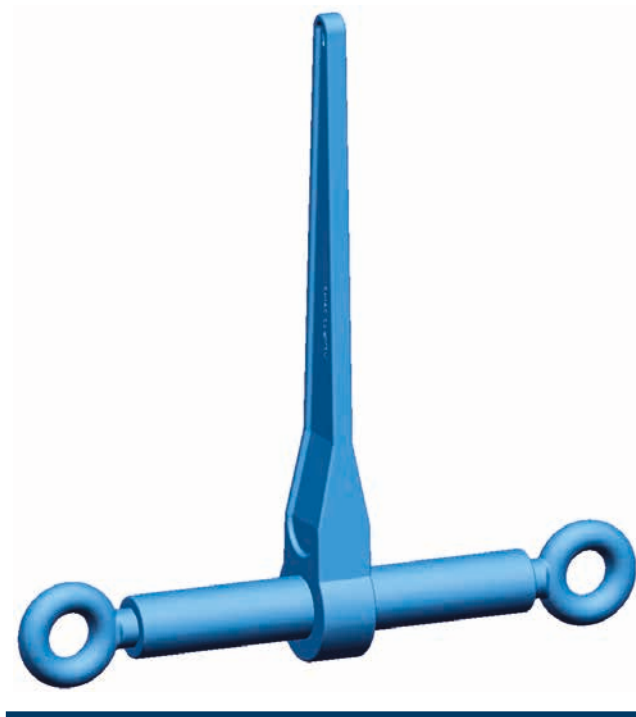

RSWP Load binder	Code	Marking / stamping	LC Lashing capacity [kN]	STF Standard tension force [daN]	Length closed L [mm]	Length open L [mm]	Tension range [mm]	Lever length l [mm]	D [mm]	d [mm]	Weight [kg/pc.]
	RSWP 7/8	Type A	60	1,900	355	500	145	237	20	16	3.20
	RSWP 10	Type B	100	3,000	365	510	145	355	26	18	3.80
	RSWP 13	Type C	160	2,500	576	866	290	359	31	22	9.90

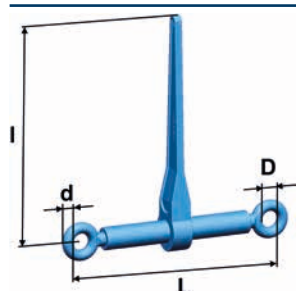

pewag RSKWP Load binder

Assurance, double sure.

This load binder, newly developed by pewag, stands for safety at the highest level. It is suitable for direct lashing as well as for lashing down in the pewag winner pro Connex system (always take note of the STF value).

The slot on the lever snaps securely into place either between two nubs or over one nub, and the added safety catch ensures that the load binder remains in the correct position, offering double safety for the user by preventing the unintended loosening of the lashing assembly. The flat design, obtained by folding down the lever, reduces the risk of injuries for users and prevents them from getting caught in the assembly. The load binder also comes with several additional advantages: it is easy to store and to transport and also offers theft protection as it may be locked using a separate shackle lock.

The long tension distance makes the load binder particularly easy to use as the chain may be shortened and tensioned with a minimum amount of force. Thanks to the open system, the safety catch and the thread condition are easy to check and maintain as needed. The RSKWP load binder is manufactured according to EN 12195-3 with the mechanical values for G12 and comes with a full operating manual.

Note: The RSKWP load binder may also be used for lifting operations. Please contact pewag for more information.

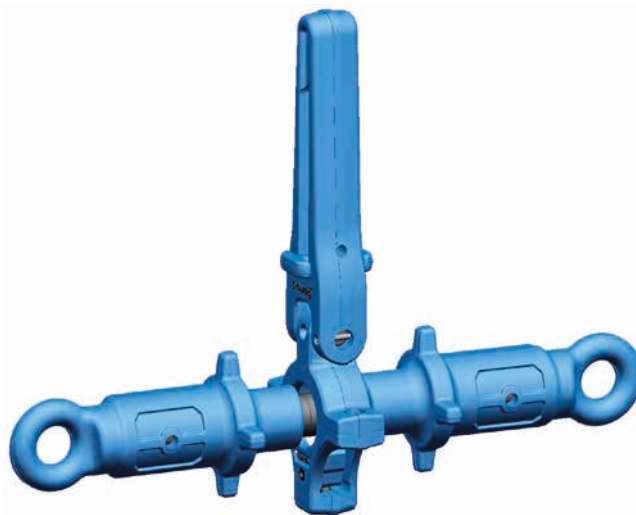

RSKWP Load binder	Code	LC Lashing capacity [kN]	STF Standard tension force [daN]	Length closed L [mm]	Length open L [mm]	Tension range [mm]	Lever length l [mm]	D [mm]	d [mm]	Weight [kg/pc.]
	RSKWP 7/8	60	2,200	536	176	360	237	23	16	5.20
	RSKWP 10	100	2,500	536	176	360	360	23	16	5.50

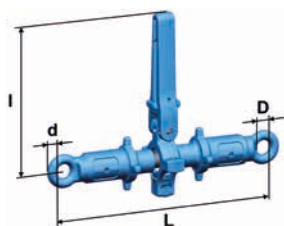

Comparison between G8, G10 and G12 pewag lashing chains

Direct lashing of loads on trucks

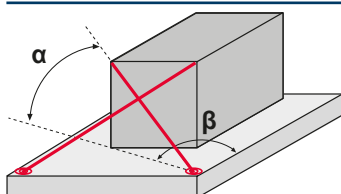

When using 4 lashing chains of	Admissible load of weight when using 4 lashing chains $\alpha = 35^\circ$, $\beta = 30^\circ$, friction coefficient $\mu = 0.3$		
	ZRS G8	ZRSW G10	ZRSWP G12
Lashing chain 8 mm	11.650	14.550	17.450
Lashing chain 13 mm	29.150	39.050	46.650

pewag RSPSWP Load binder

The element for tension.

This load binder for two-part lashing chain systems in accordance with EN 12195-3 is intended for the ZKWP lashing chain. It includes a pre-mounted shortening hook including safety catch and, depending on the selected lever length, all sizes are also suitable for frictional lashing (always take the STF value into account!). As specified in the full operating manual, this load binder is not suitable for lifting or attaching loads. The lashing capacity is 50 % higher than for grade 8.

Thanks to the pre-mounted shortening hook, the load binder may be positioned anywhere in the ZKWP lashing chain. In short, this element is bound to create some tension!



RSPSWP Load binder	Code	LC Lashing capacity [kN]	STF Standard tension force [daN]	Length closed L [mm]	Length open L [mm]	Tension range [mm]	Jaw size g [mm]	Lever length l [mm]	Weight [kg/unit]
	RSPSWP 13	160	2,500	981	1278	297	359	17	15.7
	RSPSWP 8	60	1,900	600	755	155	237	10	4.90
	RSPSWP 10	100	3,000	674	829	155	355	13	6.70
	RSPSWP 7	47	1,900	586	741	155	237	10	4.60

pewag ZRSWP | HSWP – HSWP – PSWP Lashing chain

Build your own.

This lashing chain surpasses the requirements of EN 12195-3 as it has a 50 % higher lashing capacity than standard G8 lashing chains. The lashing chain comes in a modular design with a standard length of 3,500 mm and is also suitable for frictional lashing, provided that the STF value is taken into account. Other end fittings and/or combinations and delivery lengths are available upon request and with short delivery times.

Please note that the product must not be used for lifting or attaching loads. A full operating manual tells you all you need to know about how to use the chain to its best advantage. Make sure you also refer to the tables "Direct lashing" and "Frictional lashing" for a useful overview.



Code	LC Lashing capacity [kN]	STF Standard tension force [daN]	Length closed L [mm]	Length open L [mm]	Tension range [mm]	Jaw size g1 [mm]	Weight [kg/pc.]
ZRSWP 7 200 HSWP-HSWP-PSWP 3500 CONNEX	47	1,900	355	500	145	26	9.30
ZRSWP 8 200 HSWP-HSWP-PSWP 3500 CONNEX	60	1,900	355	500	145	26	10.60
ZRSWP 10 200 HSWP-HSWP-PSWP 3500 CONNEX	100	3,000	365	510	145	31	16.80
ZRSWP 13 200 HSWP-HSWP-PSWP 3500 CONNEX	160	2,500	576	866	290	39	33.00

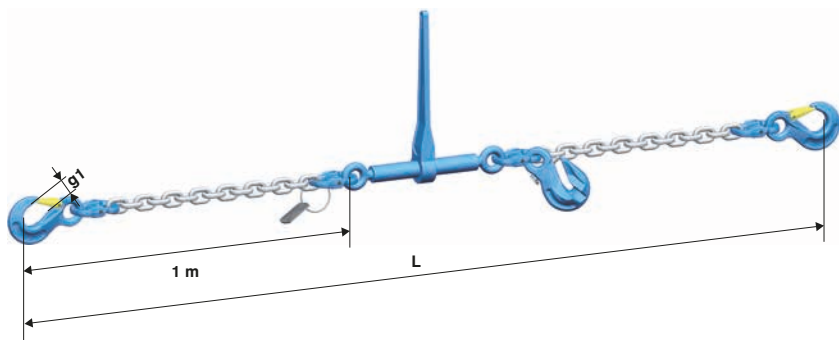

pewag ZRSWP I KHSWP – KHSWP – PSWP Lashing chain

Short-term delivery time for long-term benefits.

This lashing chain surpasses the requirements of EN 12195-3 as it has a 50 % higher lashing capacity than standard G8 lashing chains. The lashing chain comes in a modular design with a standard length of 3,500 mm and is also suitable for frictional lashing, provided that the STF value is taken into account. Other end fittings and/or combinations and delivery lengths are available upon request and with short delivery times.

Please note that the product must not be used for lifting or attaching loads. A full operating manual tells you all you need to know about how to use the chain to its best advantage. Make sure you also refer to the tables "Direct lashing" and "Frictional lashing" for a useful overview.

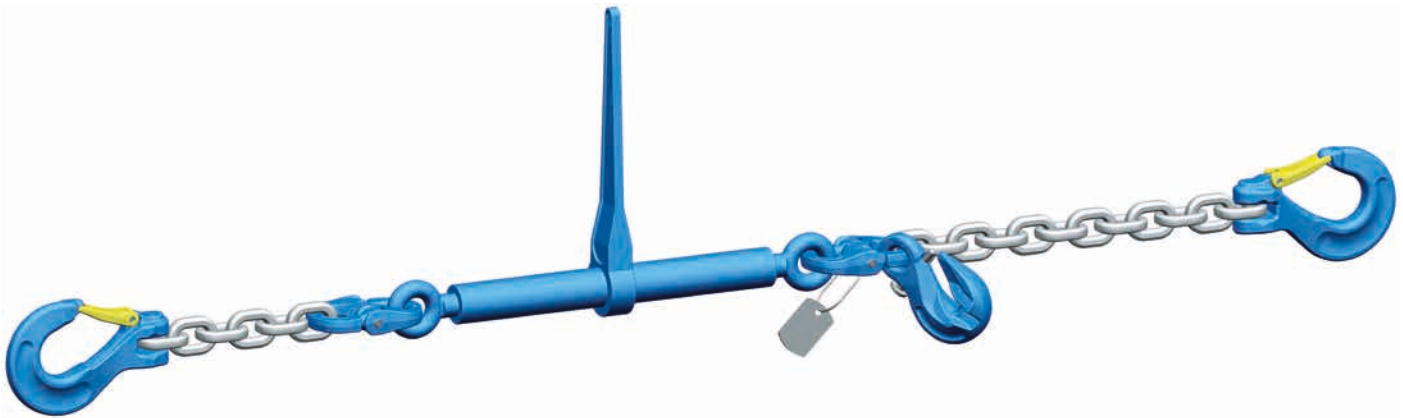

Code	LC Lashing capacity [kN]	STF Standard tension force [daN]	Length closed L [mm]	Length open L [mm]	Tension range [mm]	Jaw size g1 [mm]	Weight [kg/pc.]
ZRSWP 7 200 KHSWP-KHSWP-PSWP 3500 CONNEX	47	1,900	355	500	145	36	9.80
ZRSWP 8 200 KHSWP-KHSWP-PSWP 3500 CONNEX	60	1,900	355	500	145	36	13.80
ZRSWP 10 200 KHSWP-KHSWP-PSWP 3500 CONNEX	100	3,000	365	510	145	41	16.90
ZRSWP 13 200 KHSWP-KHSWP-PSWP 3500 CONNEX	160	2,500	576	866	290	49	33.10

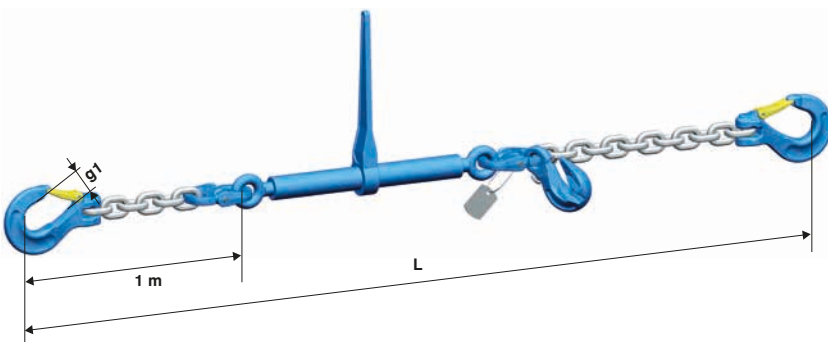

pewag[®] ZKWP I HSWP – HSWP Lashing chain

Outstanding quality for lasting benefits.

This lashing chain is used for a two-part system and it surpasses the requirements of EN 12195-3 as it has a 50 % higher lashing capacity than standard G8 lashing chains. It comes in a modular design and a standard length of 3,500 mm. Other end fittings/ combinations and delivery lengths are available upon request and with short delivery times.

Please note that the product must not be used for lifting or attaching loads. A full operating manual tells you all you need to know about how to use the chain to its best advantage. Make sure you also refer to the tables "Direct lashing" and "Frictional lashing" for a useful overview.



Code	LC lashing capacity [kN]	L [mm]	Jaw size g1 [mm]	Weight [kg/pc.]
ZKWP 7 200 I HSWP-HSWP 3500 CONNEX	47	3,500	26	5.73
ZKWP 8 200 I HSWP-HSWP 3500 CONNEX	60	3,500	26	6.79
ZKWP 10 200 I HSWP-HSWP 3500 CONNEX	100	3,500	31	11.67
ZKWP 13 200 I HSWP-HSWP 3500 CONNEX	160	3,500	39	21.07

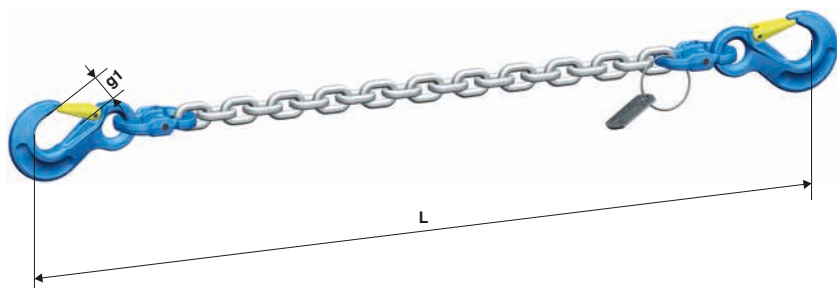

pewag ZKWP I KHSWP – KHSWP Lashing chain

Two parts for perfect strength.

Also this lashing chain is used for a two-part system and it surpasses the requirements of EN 12195-3 as it has a 50 % higher lashing capacity than standard G8 lashing chains. This lashing chain is built with clevis hooks. It comes in a modular design and a standard length of 3,500 mm. Other end fittings/combinations and delivery lengths are available upon request and with short delivery times.

Please note that the product must not be used for lifting or attaching loads. A full operating manual tells you all you need to know about how to use the chain to its best advantage. Make sure you also refer to the tables "Direct lashing" and "Frictional lashing" for a useful overview.



Code	LC lashing capacity [kN]	L [mm]	Jaw size g1 [mm]	Weight [kg/pc.]
ZKWP 7 200 I KHSWP-KHSWP 3500	47	3,500	36	6.15
ZKWP 8 200 I KHSWP-KHSWP 3500	60	3,500	36	7.05
ZKWP 10 200 I KHSWP-KHSWP 3500	100	3,500	41	11.82
ZKWP 13 200 I KHSWP-KHSWP 3500	160	3,500	49	21.08

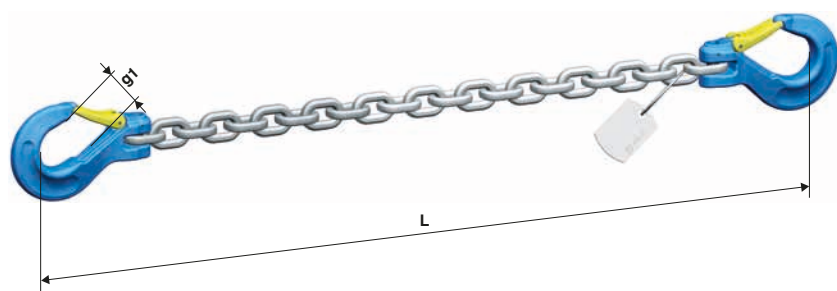

Spare parts

Product overview

Content

CBHWP Bolts + safety bush	66
SFGWP Safety catch set	66
SFGWP-K Safety catch set	67
KBSWP Clevis load pin	67
VLHWP Trigger sets	68
PSGWP Safety catches	68
IDWP Tag sets for lifting	69
IDWP Tag set for lashing	69





pewag CBHWP Bolts + safety bush

Quality assurance.

The spare parts for CWP Connex consist of a high-strength, tempered bolt and a double tensioning sleeve.

To maintain our outstanding quality standards, we recommend replacing each safety set after it has been assembled/disassembled three times.



CBHWP Bolts + safety bush	Code	For connex type
	CBHWP 7	CWP 7
	CBHWP 8	CWP 8
	CBHWP 10	CWP 10
	CBHWP 13	CWP 13
	CBHWP 16	CWP 16

pewag SFGWP Safety catch set

Unusual as usual.

This spare parts set consists of a die-forged, galvanised safety catch, a safety spring made from stainless spring steel and a safety sleeve.

It is the perfect safety catch set for HSWP eye sling hooks.



SFGWP Safety catch set	Code	For hook type
	SFGWP 7/8	HSWP 7/8
	SFGWP 10	HSWP 10
	SFGWP 13	HSWP 13

pewag SFGWP-K Safety catch set

A safe trio.

This set consists of a die-forged, tempered and galvanised safety catch, a safety spring made from stainless spring steel and a safety sleeve, making it the ideal spare parts set for KHSWP clevis hooks.

Maximum safety is guaranteed with this set.



SFGWP-K Safety catch set

Code

For hook type



SFGWP-K 7/8

KHSWP 7 + KHSWP 8

SFGWP-K 10

KHSWP 10

SFGWP-K 13

KHSWP 13

SFGWP-K 16

KHSWP 16

pewag KBSWP Clevis load pin

Stamped for quality.

The spare clevis load pin for KHSWP clevis hooks consists of a high-strength, tempered bolt with coropro coating and a safety sleeve.

To facilitate identification, the bolt is stamped with the manufacturer's name and grade "12".



KBSWP Clevis load pin

Code

For hook type



KBSWP 7

KHSWP 7

KBSWP 8

KHSWP 8

KBSWP 10

KHSWP 10

KBSWP 13

KHSWP 13

KBSWP 16

KHSWP 16 + KPWP 16

pewag VLHWP Trigger sets

Lock, stock and barrel.

The trigger set for LHWP safety hooks consists of a high-strength safety lever, a spring made from stainless spring steel and a safety sleeve.

For maximum ease-of-use, the sets come with auxiliary material to facilitate assembly as well as detailed assembly instructions.

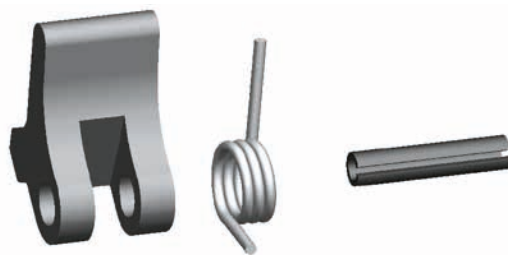

VLHWP Trigger sets

Code

For hook type



VLHWP 7/8

LHWP 7/8

VLHWP 10

LHWP 10

VLHWP 13

LHWP 13

pewag PSGWP Safety catches

Accident insurance.

The spare parts for PSWP parallel hooks with safety mechanism consist of a safety bolt, a spring made from stainless steel and a nut.

We recommend protecting the nut against accidental release by using a prick-punch or glue.



PSGWP Safety catches

Code

For hook type



PSGWP 7/8

PSWP 7/8

PSGWP 10

PSWP 10

PSGWP 13

PSWP 13

pewag IDWP Tag sets for lifting

Purpose-built for extra safety.

pewag winner pro lifting chains come with extremely useful and safety-enhancing load capacity tags. The tag set is suitable for single- and multiple-leg chain slings, the rope is stainless and the fastener is made from aluminium.

Purpose-built spare parts in a smooth, flat design.



IDWP Tag sets for lifting	Code	For lifting chains	Consisting of
	IDWP Tag set neutral	I- and multi-leg slings	Tag neutral + rope with quick-release fastener + safety information

pewag IDWP Tag set for lashing

Smooth and reliable.

The stainless lashing tag set for pewag winner pro lashing chains is quality-tested and extremely safe to use.

The fastener is made from aluminium that will withstand even the most adverse conditions. Spare parts you can rely on!

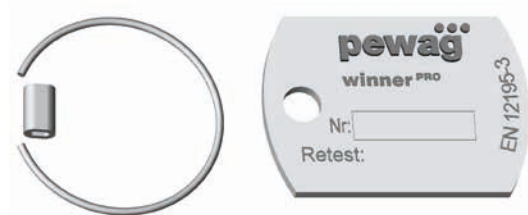

IDWP Tag set for lashing	Code	For lashing chains
	IDWP Tag set lashing	-

User information

for lifting and lashing in G12

Content

User information for pewag lifting program	72-75
User information for pewag lashing program	76-77
Notes	78





User information

General information and safety-specific information on usage, storage, inspection and maintenance of pewag lifting equipment.

General information

Like many other pewag quality products, the pewag winner pro chain system stands out for its versatility and flexible application modes when it comes to lifting loads. Prior to use, a competent person must determine whether the equipment is suitable for the intended application. If in doubt, please consult pewag directly. All information on the area of application is based on EN 818-6. All information on the assembly of chain slings and their load capacity refers without exception to the standard method of rating (Uniform Load) with the angle ranges 0–45° and 45–60°.

There is also an alternative method in existence for rating the product load capacity, for which the specific application scenario of the chain and all operating conditions must be known. In such a case, please contact the pewag Technical Service team, as the information contained in the catalogues does not apply to such processes. pewag winner pro lifting chains may only be adjusted, inspected and serviced by competent personnel.

Responsibility is key

If pewag lifting accessories is used correctly and by competent persons, it has a long lifespan and provides the highest possible safety standards.

Material and personal damage can be avoided by reading this user information carefully and handling all lifting processes in a responsible, provident manner.

Changes to the condition as delivered

Modifying the original condition of the lifting accessories by bending, grinding, removal of parts, welding, drilling, stamping etc. means exposing yourself and others to unnecessary danger. In such a case, safety can no longer be guaranteed and usage becomes dangerous. Such potentially hazardous modifications include heating the chains to a temperature of more than 300 °C in case of WINPRO FLEX 300 and 200 °C in case of WINPRO FLEX 200 and removing safety parts such as safety pins, sleeves, catches etc. Do not apply any surface coatings to the pewag winner pro chain system, i.e. do not subject products to hot galvanising or electrogalvanising. Dipping or removing a coating with chemicals are potentially dangerous processes that may give rise to hazards.

We urgently recommend customers to check with the pewag technical team first.

Assembly of chain slings

pewag winner pro chains and accessories may only be assembled by competent persons using exclusively original parts contained in the scope of delivery, i.e. bolts, safety pins etc. As pewag winner pro chains and components have only limited compatibility with chains and components of other suppliers, each individual case where pewag winner pro chain system parts are combined with components from other suppliers and/or parts made from other grades must be assessed by a competent person. Please note that pewag accepts not liability for damage resulting from such combinations.

Please ensure that the load capacity is based on the weakest link in the assembly during every application. Labelling and/or colour-coding help prevent situations where the load capacity is misjudged – for pewag, this is a key safety factor!

To ensure safe identification, pewag winner pro lashing chains must be labelled with a purpose-built load capacity tag. This tag may only be used if the load capacity of the chain corresponds to the tables on page 18/19. In situations where the load capacities are different due to combinations with products of other suppliers, this must be highlighted with a different tag (for instance round-shaped).

Restrictions of use

For hazardous or dangerous conditions, please refer to the table on page 20.

Temperature effects

The table on page 20 lists the load reduction values in case of extreme temperatures. These values apply until the chain and/or the components have returned to room temperature. pewag winner pro lifting equipment must not be used outside the indicated temperature range! If this has been the case, the chains must be removed from service.

Exposure to acids, caustic solutions or chemicals

pewag winner pro lifting accessories must not be used in acids or caustic solutions or be exposed to their vapours. Please be aware of this requirement at all times as certain production processes release acids and/or vapours! If the use of pewag winner pro lifting accessories with highly concentrated chemicals in combination with high temperatures cannot be avoided, please make sure to obtain the express approval of such usage by a pewag expert.

Hazardous conditions

The working load limits in this catalogue have been determined on the basis that the product is not being used in hazardous conditions. Hazardous conditions are present when lifting accessories are used offshore or for the lifting of persons or potentially dangerous goods such as liquid metal, corrosive or caustic substances or nuclear material. If lifting accessories is to be used for such purposes, the extent of the risk is to be assessed by an expert, the load capacity must be adjusted accordingly and incorrect usage in hazardous conditions must

be avoided at all cost. As a rule, usage in hazardous conditions should be avoided.

Prevention is better than cure!

Before using any lifting accessory, several inspections must be performed:

- Does the lifting chain correspond to the order?
- Has the inspection certificate or certificate of conformity been supplied?
- Do the markings and load capacities stated on the chain sling correspond to the information given on the inspection certificate or certificate of conformity?
- Have all the particularities of the chain sling been entered into a register of lifting equipment, if required?
- Has the operating manual outlining the correct use of the chain sling been supplied and read and understood by all personnel?

Please check the lifting accessories for visible signs of damage or wear prior to each use. In case of any doubt or damage, do not use the chain slings and have them inspected by a competent person.

Inspections by a competent person must be performed in accordance with national legislation, but at least once every 12 months. If the chain sling is frequently used at its full load capacity, more frequent inspections are required! Please note that the chain sling must also be inspected after unusual events, for instance uncontrolled exposure to heat, overloading or collision.

We recommend subjecting the chain sling to a load capacity test with 1.5 times the load capacity every two years, followed by a visual inspection, or another type of crack test.

Visual inspection criteria

If at least once of the criteria listed below manifests itself during the visual inspection, all parts must be removed from service.

- Breakage of a component
- Illegible or missing marking of the chain sling (i.e. information on identification data and/or load capacity)
- Deformation of suspension or sling parts or the chain itself
- Elongation of the chain resulting in $t > 1.05 t_n$
- Wear as determined by the mean value of two measurements of diameters d_1 and d_2 carried out at a right angle as shown

The chain must be replaced when any of the following conditions apply:

$$d_m = \frac{d_1 + d_2}{2} \leq 0,9 d_n$$

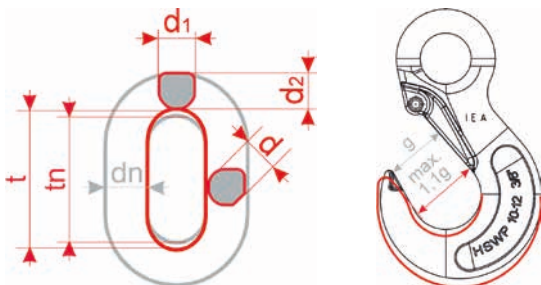

- Wear of edges if $d < d_n$
- Visible damage such as cuts, notches, grooves, surface cracks, discolouration due to excessive heat exposure, signs of subsequent welding, bent or twisted links or other flaws
- Cracks and cross-cracks that are visible to the naked eye
- Missing or non-functional safety device as well as signs of widening or twisting of hooks, i.e. noticeable enlargement of the opening or other forms of deformation. The critical point is reached when the enlargement of the opening exceeds 10 % of the nominal value. If the safety catch is open, as this indicates that the hook is overloaded

Maximum approved dimensional change (based on the nominal dimension):

Designation	Dimension	Admissible deviation
Chain	d_n	-10 %
	t_n	+5 %
	wear at edges	$d = d_n$
Rings	d	-10 %
	t	+10 %
Hook	e	+5 %
	d_2 and h	-10 %
	g	+10 %
Connecting links	halves must be moveable	must be given
	e	+5 %
	c	-10 %
	d	-10 %
Clevis and Connex bolts	d	-10 %

Correct maintenance

Please note that all maintenance activities of pewag lifting accessories must be handled by competent persons! Only pewag winner pro spare parts may be used to minimise the risk of improper use.

Precise documentation

All inspections and their results must be recorded and these records be kept throughout the service life of the chain slings. Precise records of this sort constitute the best basis for effective maintenance.

Clean storage

pewag lifting chains must always be stored in a clean and dried condition and protected against corrosion, i.e. slightly lubricated.

Correct use of chain slings

The right angle of inclination

To ensure safe handling, the slinging points and chain sling types must be selected in such a way that the angles of inclination of all chain strands (legs) lie within the data given on the load capacity tag. Preferably, all angles of inclination should be the same. Avoid angles of inclination of less than 15° because of the high risk of load instability. Never use chain slings with the angle of inclination exceeding 60°!

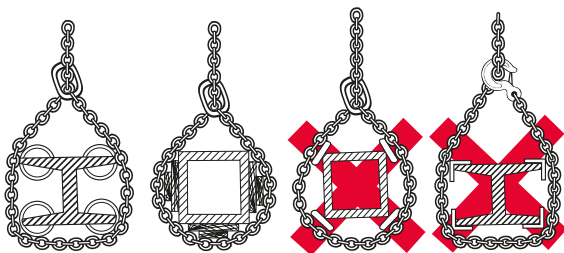

Edge-loading – know your limits

The maximum load capacity of pewag winner pro chain slings assumes that the individual chain legs are pulled straight under load, i.e. that they do not run over edges. However, if edge-loading is unavoidable, load protection (packing) should be used to avoid damage (see illustration):

If chains are guided over edges without proper protection, their load capacity is significantly reduced and safe usage can no longer be guaranteed. See the table on page 20 for the corresponding load factors. Where chains have to be looped around beams or other round-shaped loads, the diameter should be at least twice or 3 times the chain pitch.

For smaller diameters, the load capacity of the chains must be reduced by 50 %.

Impact-/shock-loading

For the load capacities of pewag winner pro lifting chains to apply, it is assumed that the individual chain strands are not subjected to impact- or shock-loading. In cases of possible impact/shock, the load factors on page 20 apply.

Classification of impacts

- Slight impact may result from accelerated lifting or lowering operations
- Medium impact may result from the chain slipping while adjusting itself to the shape of the load
- Strong impact results for instance from the load falling into the unloaded chain

Vibrations

If they are used correctly, pewag winner pro lifting chains and accessories withstand high load cycles. pewag products come with a standard rating of 20,000 load cycles. However, in case of high dynamic loads there is a risk of damage to the chain or chain components.

The Berufsgenossenschaft Metall Nord Süd recommends reducing stress at WLL by using a larger nominal thickness/size in such a case.

Symmetrical loading

For the load capacities of pewag winner pro lifting chains to apply, it is assumed that the individual chain strands are placed under load symmetrically.

When the load is lifted, this results in equal angles of inclination and the individual strands are symmetrical to each other.

The load may be considered symmetrical when all of the following conditions apply:

- The load is less than 80 % of the indicated load capacity
- The angles of inclination of all chain strands are not lower than 15° and are very similar (i.e. only differ by a maximum of 15°)
- For three- and four-stranded lifting chains, it must be ensured that the corresponding plan angles are within 15° of each other

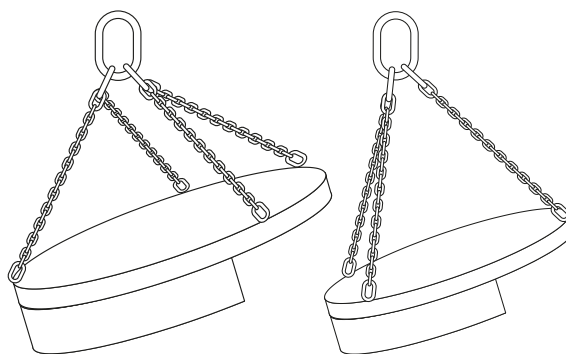

The main part of the load is carried by just one leg.

The main part of the load is carried by two legs.

Be careful!

If not all of these parameters are complied with, the load cannot be considered symmetrical and the classification of the lifting operation must be left to an expert. In case of doubt, only one chain strand (leg) should be considered as load-bearing. For the corresponding load capacity values, please refer to the load capacity table on page 18 and 19.

Wrongful use defeats the purpose

pewag winner pro lifting chains offer perfect quality standards if they are used according to their intended purpose. In cases where not all individual legs are used simultaneously or where several lifting chains are used at the same time, different load capacities apply as outlined in the tables on page 20. In case of doubt regarding the intended purpose, the load capacity as indicated on the tag must be amended in accordance with the following table:

Type of sling chain	Number of individual strands used	Use factor in relation to the load capacity given on the tag
two-stranded (II-leg)	1	1/2
three- and four-stranded (III/IV-leg)	2	2/3
three- and four-stranded (III/IV-leg)	1	1/3
2 x single-stranded (single leg)	2	1.4
2 x two-stranded (II-leg)	3 or 4	1.5

Precautions

- Hang any individual strands (leg) that you are not using back into the master link to prevent hazards caused by freely swinging chains or unintended hooking
- Before using several chain slings at the same time, make sure that the crane hook is big enough for all the master rings. Make sure that the master rings cannot fall out of the hook during lifting
- Angles of inclination of more than 45° must be avoided
- Use only chain slings of the same nominal thickness and grade at the same time

Detailed original operating manuals for individual products are available for download at www.pewag.com. Our manuals are subject to a continuous improvement process to ensure that they are always up to date. For this reason, always refer to the latest version of a manual.

User information

User information on pewag winner lashing system

General information

In general, the same information applies to the pewag winner pro chain system if used as lashing equipment as to lifting purposes. However, the following additional information must be taken into account:

- pewag winner pro lashing chains were developed to secure loads during transport. If used correctly, the lashing chains have a long lifespan and provide the highest possible safety standards. Personal and material damage are best prevented by ensuring correct use. Please note that pewag winner lashing chains may only be used once the user information has been read and understood in full. A responsible, provident approach towards load-securing is crucial at all times
- We offer tools to assist with selection and proper usage of the lashing chain assemblies. Nevertheless, adequate experience of load securing and use of lashing equipment is indispensable
- Only authorised and competent persons as defined by EN 12195-1 and 2 are allowed to assemble and use pewag winner pro lashing chain systems
- Important: lashing chains have safety factor = 2, lifting chains have safety factor = 4! This means that, for safety reasons, lashing chains must never be used as lifting chains! To ensure safe handling, lashing chains must always have the correct identification tag with the appropriate warning
- When the number of the lashing assemblies is calculated according to EN 12195-1, some impact loads may arise that are not reflected in the calculation but which will be balanced by the vehicle and by the flexibility of the lashing system

Information on use

Lashing points

Choose lashing points in such a way that the angles of the lashing chain assemblies are within the range given in our lashing table and the lashing chain assemblies are symmetrical to the driving direction. Use only lashing points with adequate strength. Any deviations are subject to prior consultation with the pewag technical service department.

Safe selection

When selecting the appropriate lashing chain system, consider the lashing method required and the load that needs to be secured. Size, shape and weight of the load as well as the intended usage category (lashing down, direct lashing, ...) and the transport environment (additional utilities, lashing points, ...) must be taken into account for selecting the appropriate system.

For **lashing down**, we recommend using lashing straps because of their low weight and higher elongation. Only select lashing equipment where the label or tag specifies an STF value.

For **direct lashing**, we recommend using lashing chains because of the high lashing capacity and low elongation. To ensure that the minimum number of lashing systems is used, we recommend direct lashing to secure loads, especially for heavy loads. The number of lashing systems may be calculated according to EN12195-1.

In accordance with this standard, pewag has integrated **the most commonly used lashing methods** in easy-to-use lashing tables. For more detailed information, please refer to pages 44 and 45.

For optimal stability, always use at least two lashing chains for lashing down and two pairs of lashing chains for diagonal lashing. Always ensure that the lashing chains are both long and strong enough for the application you have in mind! When in doubt, always opt for a **higher level of safety** to prevent overloading the chains.

All connecting parts of the lashing chains such as hooks and rings must be **free to move** within the lashing point and **adjustable in the tensile direction**. Bending stress on the accessories and tip loading of the hooks are not permissible. Hooks may only be loaded at the bearing area.

Lashing chains should **never be used in conjunction with lashing straps** as different lashing devices display different behaviours and elongation properties under load (for instance in case of straps and chains made of chemical fibre). If you have any further questions or require information on possible exceptions, please contact the pewag technical customer service.

Proper use

Proper and correct lashing practice is at the centre of any safe application. Before lashing, plan the lashing process and the release/opening of the lashing system. During a longer trip, consider possible partial unloading. Watch out for overhead lines during loading and unloading and remove all lifting devices before starting the lashing process.

The **maximum manual force** of 50 daN applied during the tensioning of the tensioning equipment may only be applied by hand!

Do not use mechanical auxiliary devices such as levers or bars. Ensure sufficient edge protection/friction protection.

Also check the **tension of the lashing chain** regularly during transport. Before opening the lashing chain system, always check that the load is safe and that there is no risk of goods falling off or toppling down. Where required, attach any lifting equipment for further transport to the load immediately.

Prior to unloading, the lashing chains must be released far enough to ensure that the load is free-standing. Always ensure that there is no risk of the lashing chain getting tangled up during unloading.

Dynamic friction coefficient

Different dynamic friction coefficients apply to different material pairs, as shown in the following table: If in doubt, apply the lower value with the worse adhesion factor.

Material	dry	wet	oiled
Wood/Metal	0.20 – 0.50	0.20 – 0.25	0.05 – 0.15
Metal/Wood	0.20 – 0.50	0.20 – 0.25	0.02 – 0.10
Metal/Metal	0.10 – 0.25	0.10 – 0.20	0.01 – 0.10
Concrete/Wood	0.30 – 0.60	0.30 – 0.50	0.10 – 0.20



pevæg
wibner pfa 200 G12
Nr 17200001
10°
45° 7100 kg
60° 5000 kg

W 12 CE
GWP 10
MFC

pevæg

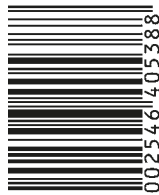

KA/17/00372 9



www.pewag.com

pewag austria GmbH

A-8041 Graz, Gaslaternenweg 4, Phone: +43 50 50 11-0, Fax: +43 50 50 11-100,
saleinfo@pewag.com, www.pewag.com

